



The Directory 2025

**tcgroup**  
spaces people love



**People are at the heart of our company, whether it's the people using our products, the people selling them or the dedicated team working behind the scenes.**

We offer a wide variety of office and educational seating, desking, storage, conference and training furniture – with a firm focus on service and support. We work hard to develop innovative, new products based on an understanding that our customers' space requirements are ever-evolving.

By investing our efforts into sourcing quality products for our customers across the UK and further afield; we ensure our range caters for every need with delivery services to match.



The mark of responsible forestry

### **Forest Stewardship Council** C196959

Furniture isn't just about looking good and being functional; it's also about having a minimal environmental footprint. Our wooden desking and furniture is FSC certified with a full chain of custody.



ISO 9001  
Certificate No. GB2005241

### **Quality Management** BS EN ISO 9001:2015

This accreditation ensures that all of our products, processes and systems are monitored and measured. They regularly go through management review ensuring compliance with the regulatory requirements of this International Quality Standard.



ISO 14001  
Certificate No. EM2000925

### **Environmental Policy** BS-EN ISO14001:2015

We care about the environment and to show this, we regularly evaluate our procedures and implement new strategies to reduce our ecological footprint. We measure, manage and control our environmental impact by being certified to ISO 14001:2015.

# Delivery, Installation and Removal Service

We are committed to giving you an exceptional experience. Our delivery, installation and removal service allows you to sit back and relax, while the experts do the heavy lifting. Our team of experienced furniture installers will get the job done on time, leaving you with a refreshed office.



Once you place your order, we will deliver and install within 7-10 working days. Our expert team of installers will:

## Delivery

- Contact you with an installation time and date in advance of their arrival.
- Arrive with a smile on their face, ready to do a great job.

## Installation

- Assemble your brand new office exactly where you'd like it.
- Dispose of all packaging correctly; recycling where possible.
- Offer a complementary product demonstration to ensure you are confident and happy with your new office.
- Clean up and vacuum the room to ensure it is spotless.

## Removal

- Remove old furniture.

Nobody can  
install our  
furniture  
better than us!



## Delivery options

We have several delivery options, all tailored to your requirements. If you need more information about our services, outlined below, please contact our Sales Team, they will be happy to help.

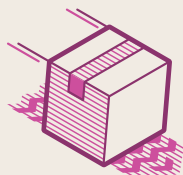

### Next Day Delivery

Need something tomorrow? Place your order for stocked products with us by 4pm, and we will ensure it reaches you by the next working day. No matter the order size, we can get you what you need, when you need it. It's that simple.



### 5-7 Day Delivery

Not in a rush? Delivery for all stocked products will be on our 5-7 day service.

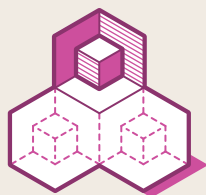

### Room of Choice

If you need some additional assistance, but not full Delivery, Installation and Removal, our Room of Choice option is the service for you. We offer a two-man delivery, to the room the products are being used. We take out all the heavy lifting and transporting of goods, leaving everything exactly how you want it.



### Nominated Day

Our priority is always making life that little bit easier for all our customers. Our Nominated Day delivery service is tailored to fit around you. You choose the day and time slot; we'll do the rest.

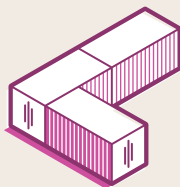

### Containerised Delivery

Your high volume products never need to go out of stock again with our containerised delivery option. Order a full container of products and enjoy a significant cost saving. We receive and monitor your order, and keep you fully informed until it reaches your door. It's that easy.

### Delivery enquiry checklist:

- What products do you need?
- Where are the products going?
- Are there any delivery restrictions i.e. is there a goods lift?

# Space Planning

Correct planning ensures you are getting the most out of your workspace. We offer a space planning service which utilises the maximum capacity of your workspace safely and efficiently.

Our experienced team use the latest software to ensure a full planning service, from site surveys and 2D plans to walk-through 3D visualisations. Just give us your measurements, and we will create and suggest possible layouts to enhance your existing office space.

## 2D plans

Our 2D plans turn your measurements into a well thought out working area to suit your particular requirements. Once your furniture plan is complete, we can be as detailed as you need and display network points, lighting, heating, power, and anything else you may require. Want to hang on to a few things? Our 2D plans can show a mix of old and new furniture designed by our experienced team.

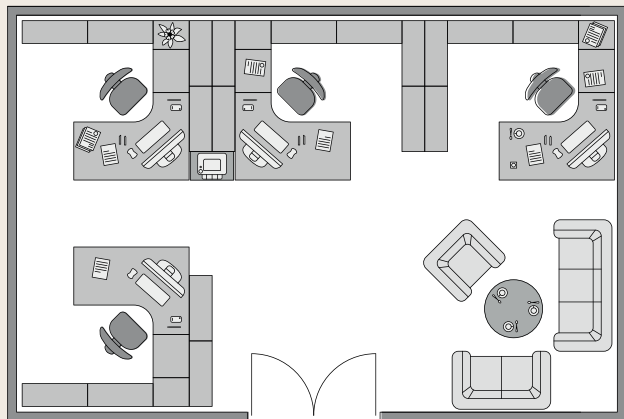

## 3D plans

We can take the 2D plan drawings a stage further by adding carpet and wall finishes, together with colour ideas to suit your corporate identity - or build on your ideas. Once created, we can produce a 3D walk-through visualisation, which enables you to see the result in a clear, concise way.

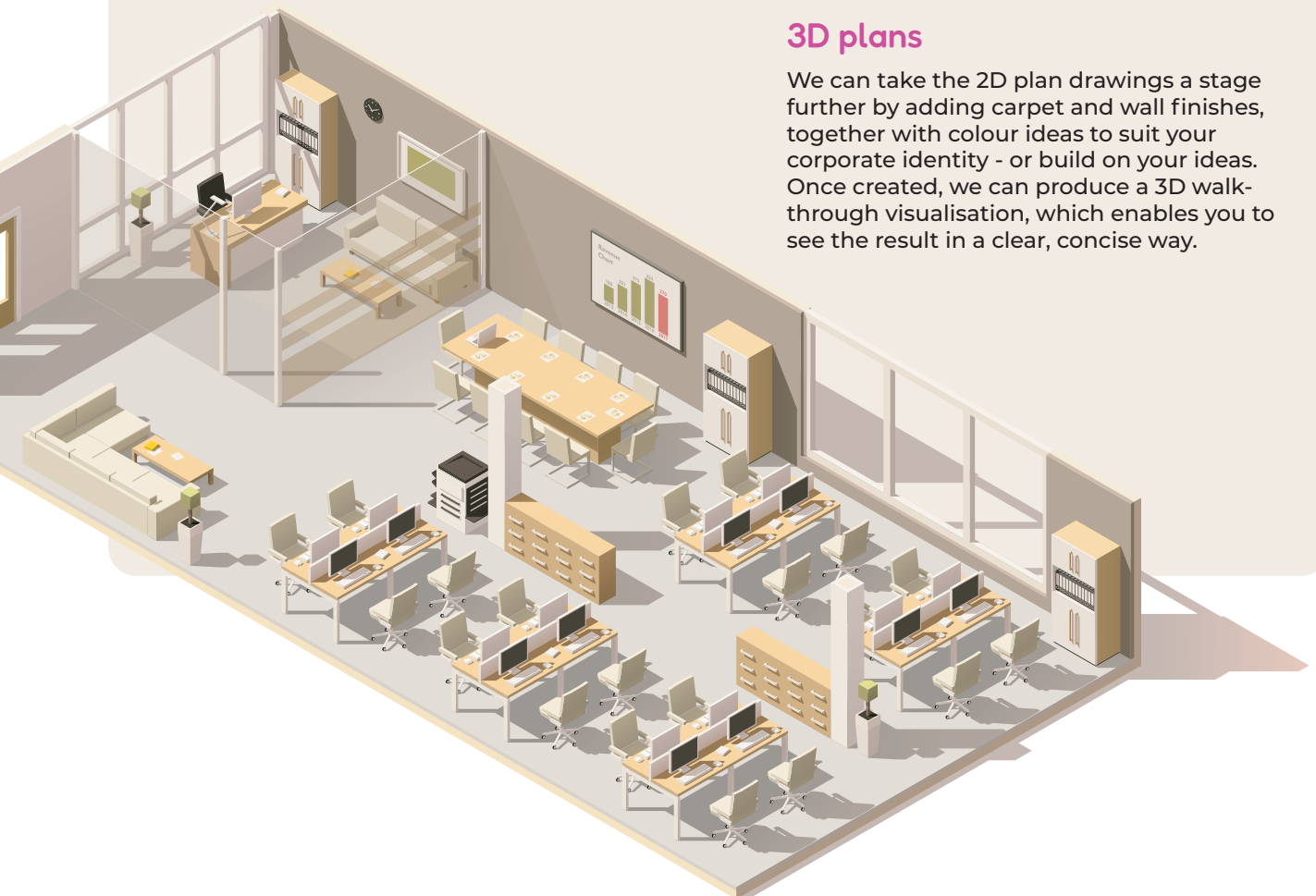

# Material Finishes



## Unlimited fabrics

Where you see this icon the product is available upholstered to your exact specification. Choose from multiple on-trend finishes to match your market place or corporate colour scheme, or if you're looking for something different to brighten up your business environment.

### Fabric banding

Should your fabric of choice not be listed, please contact our Sales Team who will be happy to assist. Please ensure you check the suitability of your selected fabric for its application before ordering.

### Leather

Priced on application.

### Fabric swatches

We recommend that your final fabric selection is made based on a physical swatch only and use printed swatches merely as a guide. Please contact our Sales Team to find out more.



## Fire safety

The fire retardancy or CRIB rating of a particular fabric measures its ability to resist ignition from an exposed flame. There are a variety of tests for the flammability of upholstery fabrics within the UK. We have listed a brief description of those applicable to our market below (please note this is not exhaustive and contact us if you need more information).

### Low Hazard

Tested to BS7176:2007, low hazard fabric ratings are suitable for use within the general office environment.

### CRIB 5

Indicates a fabric has been treated and tested to be suitable for most purposes, particularly contract environments like hotels, where the impact of a fire can be especially dangerous due to the volume of people.

### CRIB 7

This is a more stringent test version of CRIB 5. Fabric that passes this test is suitable for more hazardous environments like prisons or offshore installations.



## Material standards

All the materials used in our furniture, seating and storage ranges are carefully selected and specified to our ISO 9001 certification. We work with globally renowned manufacturers to ensure we can bring to market quality products that stand the test of time and offer an exceptional value proposition.

### Wooden furniture

Our desktops and wooden storage units are made from Forest Stewardship Council (FSC) certified Melamine Faced Chipboard (MFC).



The mark of responsible forestry

### Wood finishes

We have a wide colour palette of MFC wood finishes across our ranges of desking and storage.

### MFC supply chain

Is fully FSC (Forest Stewardship Council) certified and accredited to ISO 14001 and ISO 9001.

# camira

Camira have been weaving the fabric of the world for decades. They produce fabrics for spaces and places, from offices to schools, trains to buses, and shops to hospitals. Camira manufacture over 8 million metres of fabric a year so you're sure to have touched upon their fabrics either at work, at play or on the move. From their manufacturing plant, registered to ISO 9001 and 14001 standards, they make 8 million metres of fabric a year meeting international flammability regulations, celebrating colour, design, technical and environmental innovation.

FABRIC BAND 5

## Blazer

Task, Soft Seating, Panel

### Composition

100% Virgin Wool

### Environmental

Certified to the EU Ecolabel  
 Certified to Indoor Advantage™ Gold  
 Environmental Product Declaration -  
 Natural fabric composition  
 Rapidly renewable and compostable  
 Non metallic dyestuffs

### Weight

460 g/m<sup>2</sup> ±5%

### Abrasion Resistance

Heavy duty / 10 year guarantee.  
 Independently certified to ≥45,000  
 Martindale cycles

### Flammability

EN 1021 - 1&2 (cigarette & match)  
 BS 7176 Low Hazard  
 NF D 60-013  
 ÖNORM B 3825 & A 3800-1 (over CMHR 58kg/m<sup>3</sup> Foam)  
 UNI 9175 Classe 1 IM  
 BS 476 Part 7 Class 1 (Adhered)  
 EN 13501-1 Adhered Class D, s1, d0  
 IMO FTP Code (Part 8)  
 The Furniture and Furnishing (Fire Safety) Regulations  
 1988 (UK domestic cigarette and match)

### Light Fastness

4-6 (ISO 105 - B02)

### Fastness to Rubbing

Wet: 4, Dry: 4 (ISO 105 - X12)

### Guarantee

10 Years



CUZ28



CUZ47



CUZ4W



CUZ12



CUZ4Q



CUZ4N



CUZ4R



CUZ21



CUZ4T



CUZ2Z

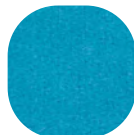

CUZ02

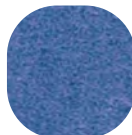

CUZ1V

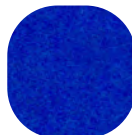

CUZ4P

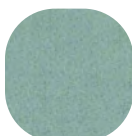

CUZ4S

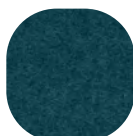

CUZ1P



CUZ26

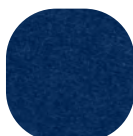

CUZ1Y



CUZ2W



CUZ4V



CUZ1N



CUZ62

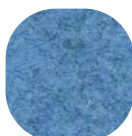

CUZ4H

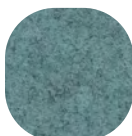

CUZ33

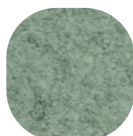

CUZ4K

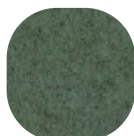

CUZ3R

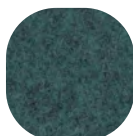

CUZ4G

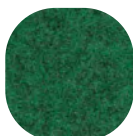

CUZ3Y

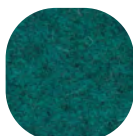

CUZ4F



CUZ82



CUZ3M

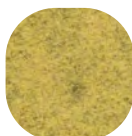

CUZ58

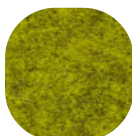

CUZ1F

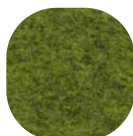

CUZ1K

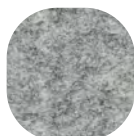

CUZ1E

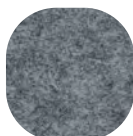

CUZ1J

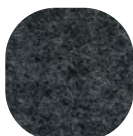

CUZ35



CUZ2Q



CUZ86



CUZ31



CUZ3T



CUZ3L



CUZ4L



CUZ90



CUZ4M



CUZ4D



## Aspect

### Task Seating / Soft Seating

#### Composition

75% Trevira® CS Flame Retardant Polyester, 25% Polyester

#### Environmental

Certified to STANDARD 100 By OEKO-TEX®  
 Certified to Indoor Advantage™ Gold  
 Non metallic dyestuffs

**Weight** 325 g/m2 ±5%

#### Abrasion Resistance

Heavy duty / 10 year guarantee.  
 Independently certified to ≥50,000  
 Martindale cycles

#### Light Fastness 5 (ISO 105 - B02)

#### Fastness to Rubbing

Wet: 4, Dry: 4 (ISO 105 - X12)

**Guarantee** 10 Years

#### Flammability

EN 1021 - 1&2 (cigarette & match)  
 BS 7176 Low Hazard  
 DIN 4102 B1  
 NF D 60-013 (Over 50kg/m3 CMHR foam)  
 ÖNORM B 3825 & A 3800-1 (over CMHR 58kg/m3 foam)  
 UNI 9175 Classe 1 IM  
 BS 5867-2 Type B Curtains & Drapes  
 EN 13501-1 Adhered Class B, s2, d0  
 EN 13501-1 Un-Adhered Class B, s1, d0

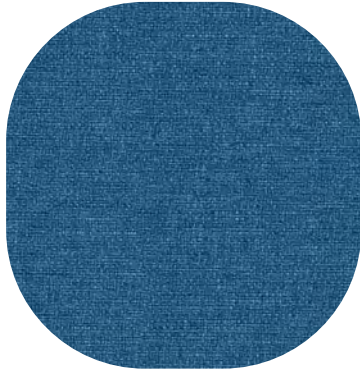

ACT23

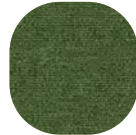

ACT18



ACT20



ACT21



ACT16

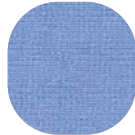

ACT19



ACT22



ACT31



ACT24

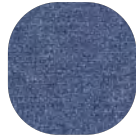

ACT26

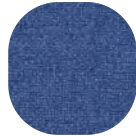

ACT27



ACT11

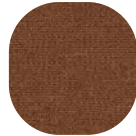

ACT12



ACT14



ACT09



ACT15



ACT08



ACT29



ACT30



ACT06



ACT04



ACT03

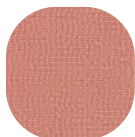

ACT07



ACT05



ACT10

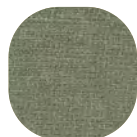

ACT17



ACT02



ACT01

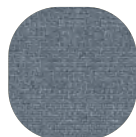

ACT28



ACT25



ACT13

## Phoenix

### Task Seating

#### Composition

100% Polyester

#### Environmental

Certified to STANDARD 100 By OEKO-TEX®  
 Certified to Indoor Advantage™ Gold  
 Environmental Product Declaration -  
 Synthetic fabric composition  
 Non metallic dyestuffs

#### Weight

285 g/m2 ±5%

#### Abrasion Resistance

Heavy duty / 10 year guarantee.  
 Independently certified to ≥100,000 Martindale cycles

#### Flammability

EN 1021 - 1&2 (cigarette & match)  
 BS 7176 Low Hazard

#### Light Fastness

6 (ISO 105 - B02)

#### Fastness to Rubbing

Wet: 4, Dry: 4 (ISO 105 - X12)

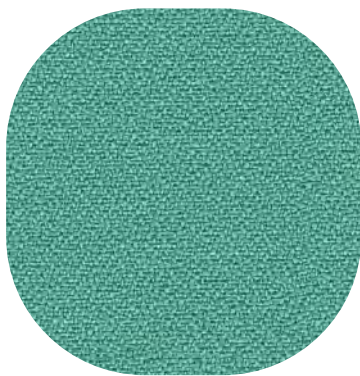

YP112

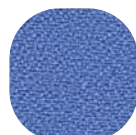

YP097



YP026

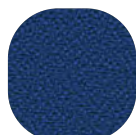

YP082

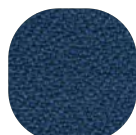

YP005



YP100

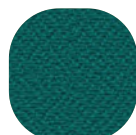

YP011

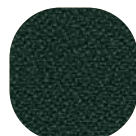

YP045



YP108



YP084

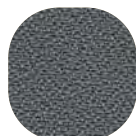

YP081

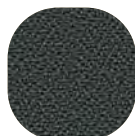

YP019



YP046

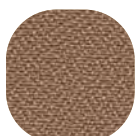

YP107



YP110

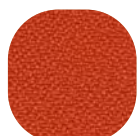

YP076

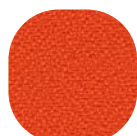

YP113

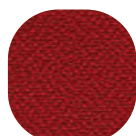

YP106



YP105



YP051



YP009



chieftainfabrics

Chieftain Fabrics are experts in vinyl upholstery. It is their only focus and they believe that for this reason, they are the best at what they do. Chieftain specialise in the design and production of high quality performance fabric and contract upholstery, and have done for over 60 years. With their unique mix of specialist expertise, innovative R&D and advanced materials, they produce an inherently better fabric. Chieftain are constantly striving to keep up with ever changing technologies and have the only fabric that has passed both the Tropical test and Crib 7.

FABRIC BAND 3

chieftainfabrics  
Just Colour



### Application

High traffic areas, stadia seating, restaurant, hotel, healthcare, prisons, high security environments etc.

### Characteristics

Surface : Phthalate free PVC  
Backing : Cotton/PES  
Weight : 705 g/m<sup>2</sup>  
Thickness : 1.10mm  
Bursting Strength : 1,200+kPa  
Abrasion : 500,000+ Martindale Rubs

### Flame Retardancy

BS5852 Ignition Source 7 - Crib 7 as standard  
BS7176 Medium Hazard  
S.I. 1988 No.1324 Schedule 4 and 5  
BS EN1021-1 and 2  
CS-25  
FMVSS 302  
IMO A 652 (16)  
M2  
B2

### Jungle / Tropical Test

ISO 1419 : 1995 Accelerated Ageing Test

### Antimicrobial

ISO 22196  
G21  
Independent testing has verified that Just Colour is effective at reducing the spread of MRSA, E.Coli, and other similar bacteria.

See Chieftainfabrics.com for further details and cleaning instructions.

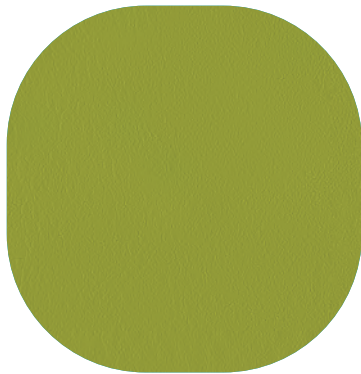

Citrus Green



Marigold



Jazzy Berry



Deep Rose



Grape



Cocoa



Jasmine White



Cobalt



Grey Friar



Ocean Blue



Sea Green



Pillar Box



Golden Honey

FABRIC BAND 1

chieftainfabrics  
Trimcell Legend



### Application

Domestic application only - not suitable for contract use.

### Characteristics

Surface : PVC  
Backing : PES or Cotton PES  
Weight : 608g/m<sup>2</sup>  
Thickness : 1.00mm  
Bursting Strength : 1,000+kPa  
Abrasion : 40,000+ Martindale Rubs

### Flame Retardancy

BS7176 Low Hazard  
S.I. 1988 No.1324 Schedule 4 and 5  
BS EN1021-1 and 2  
CS-25  
FMVSS 302  
IMO A 652 (16)

See Chieftainfabrics.com for further details and cleaning instructions.



Daisy



Antelope



Bluebell

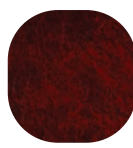

Burgundy



Charcoal



Cinnamon



Truffle



Fern



Garnet



Indigo



Iris



Poppy

# Gabriel®

Chili is a pioneering upholstery fabric distinguished by its fusion of sustainable materials and exceptional fire resistance. Made from 75% post-consumer recycled flame retardant polyester, the fabric sets new environmental standards for fire retardant fabrics. Made from post-consumer recycled flame retardant polyester, Chili uniquely combines sustainability with superior fire safety.

## Chili

### Composition

100% post-consumer recycled polyester fr  
(fr inside the fibre)

### Weight

470g/lm (15.16 oz/lin.yd)

### Abrasion Resistance

Rubs martindale (EN ISO 12947-2) 60,000  
Double rubs wyzenbeek (ASTM D4157)  
(heavy duty upholstery) 100,000

### Flammability

CA TB 117-2013  
NFP 92-503/504/505 M1  
DIN 4102 - B1  
Class Uno UNI 9175 Class 1 I EMME  
BS EN 1021 1&2 Cigarette and Match  
BS EN 1021-1 Cigarette  
BS 7176 Medium Hazard  
BS 5852 Crib 5  
AM 18 - NF D 60-013-(only for fabric)  
DIN EN 13501-1 B-s1,d0  
Will also pass other flammability standards.  
FR performance is dependent upon the  
foam used.

### Light Fastness

Scale 1-8, max. 8 - EN ISO 105-B02 5-8

### Fastness to Rubbing

Wet:4-5 Dry:4-5 (ISO 105 - X12)

Wash or dry clean

See [www.gabriel.dk](http://www.gabriel.dk) for further details  
and cleaning instructions.

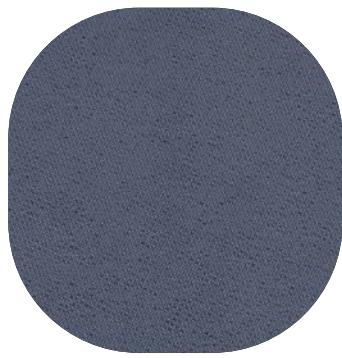

60081

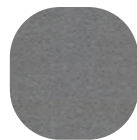

60083



60114

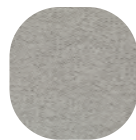

60115

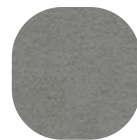

60116

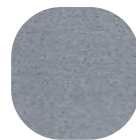

60117



60999

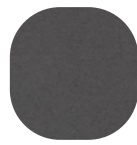

61171



61172



61173

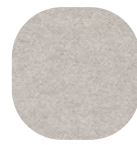

61174

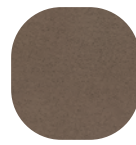

61175

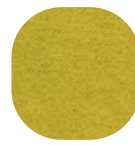

62085



62086



63090



63092



63093

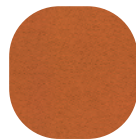

63099



64197

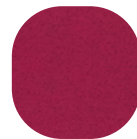

64198



64199

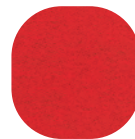

64200



64201



64202



64203



65107



85108



65109



65110

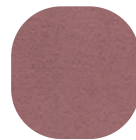

65111

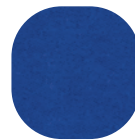

66171

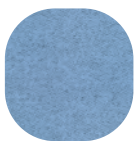

66172



66173



66174

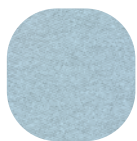

66175

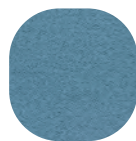

66176

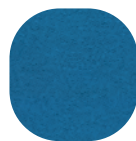

67085

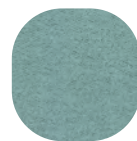

68189

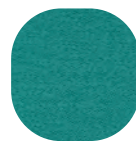

68190

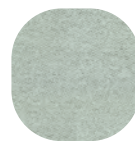

68191

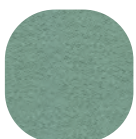

68192



68193



68194

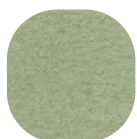

68195



68196



68197

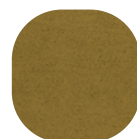

68198

## Fabric band guide



Where you see the adjacent icon, the product is available upholstered to your exact specification.

Choose from multiple on-trend finishes to match your market place or corporate colour scheme, or simply something different to brighten up your business.

Manufacturer	Material name	1	2	3	4	5	6	Leather	Wool content %	Crib fire rating	Application
Chieftain	Trimcell Classic	•							0	LOW HAZARD	TASK & SS
Chieftain*	Trimcell Legend	•							0	LOW HAZARD	TASK & SS
Chieftain	Carino		•						0	CRIB 5	TASK & SS
Chieftain*	Just Colour		•						0	CRIB 7	TASK & SS
Chieftain	Just Patterns		•						0	CRIB 5	TASK & SS
Chieftain	Lionella			•					0	CRIB 5	TASK & SS
Chieftain	Casco				•				0	CRIB 5	TASK & SS
Chieftain	Cube				•				0	CRIB 5	TASK & SS
Chieftain	Marquis				•				0	CRIB 5	TASK & SS
Chieftain	Riviera				•				0	CRIB 5	TASK & SS
Chieftain	Self Colour				•				0	CRIB 5	TASK & SS
Chieftain	Traditional				•				0	CRIB 5	TASK & SS
Chieftain	Universal				•				0	CRIB 5	TASK & SS
Chieftain	Multistretch			•					0	CRIB 5	TASK & SS
Agua	Libra		•						0	CRIB 5	TASK & SS
Agua	Paint Pot		•						0	CRIB 5	TASK & SS
Agua	Taurus collection			•					0	CRIB 5	TASK & SS
Agua	Parody			•					0	CRIB 5	TASK & SS
Agua	Nova			•					0	CRIB 5	TASK & SS
Agua	Cashmir			•					0	CRIB 5	TASK & SS
Agua	Funisoft PU				•				0	CRIB 5	TASK & SS
Camira	Cara	•							0	LOW HAZARD	PANEL
Camira*	Phoenix	•							0	LOW HAZARD	TASK
Camira	Citadel	•							0	LOW HAZARD	TASK
Camira	Rivet	•							0	LOW HAZARD	TASK & SS
Camira	Era	•							0	LOW HAZARD	TASK & SS
Camira	Advantage		•						30	LOW HAZARD	TASK
Camira	Gravity	•							0	CRIB 5	TASK
Camira	Lucia		•						0	LOW HAZARD	PANEL
Camira	Sonus		•						0	BS 476 PT.7 C.1	PANEL
Camira	Manhattan		•						0	LOW HAZARD	TASK
Camira	Racer		•						0	BS 476 PT.7 C.1	PANEL
Camira	L2		•						0	BS 476 PT.7 C.1	PANEL
Camira	Xtreme		•						0	CRIB 5	TASK
Camira	Canopy		•						0	LOW HAZARD	TASK & SS
Camira	Sprint		•						0	LOW HAZARD	TASK & SS
Camira	Chateau		•						0	LOW HAZARD	TASK
Camira	Vita		•						0	CRIB 5	TASK & SS
Camira	Urban		•						0	CRIB 5	TASK
Camira	X2		•						0	CRIB 5	TASK & SS
Camira	Main Line Plus			•					67	CRIB 5	TASK & SS
Camira*	Aspect			•					0	CRIB 5	TASK & SS
Camira	Main Line Flax			•					70	CRIB 5	TASK & SS
Camira	Honeycomb			•					0	CRIB 5	TASK & SS
Camira	Nexus			•					0	LOW HAZARD	PANEL
Camira	Blazer Lite				•				100	BS 476 PT.7 C.1	PANEL
Camira	Halcyon - Cedar				•				0	CRIB 5	TASK & SS
Camira	Halcyon - Aspen				•				0	CRIB 5	TASK & SS
Camira	Halcyon - Blossom				•				0	CRIB 5	TASK & SS
Camira	Hi-Tech				•				29	LOW HAZARD	TASK & SS

\* Featured swatches in previous fabric brand pages

Manufacturer	Material name	1	2	3	4	5	6	Leather	Wool content %	Crib fire rating	Application
Camira	Synergy				•				95	CRIB 5*	TASK & SS
Camira	Hemp				•				60	CRIB 5	TASK & SS
Camira	24/7 +				•				33	CRIB 5	TASK & SS
Camira	24/7 Flax				•				30	CRIB 5	TASK
Camira	Landscape Balance/Contact				•				95	CRIB 5*	TASK & SS
Camira	Intervene Plain/Texture				•				0	CRIB 5	TASK & SS
Camira*	Blazer					•			100	CRIB 5*	TASK & SS
Camira	Marvel		•						0	CRIB 5	TASK & SS
Camira	Aquarius					•			100	CRIB 5*	TASK & SS
Camira	Oxygen					•			90	CRIB 5*	TASK
Camira	Silk					•			67	CRIB 5	TASK & SS
Camira	Track					•			0	CRIB 5	TASK & SS
Camira	Synergy 170					•			95	LOW HAZARD	PANEL
Camira	Hebden					•			60	CRIB 5	TASK & SS
Camira	Main Line Flax Stripe				•				70	CRIB 5	TASK & SS
Camira	Individuo						•		95	CRIB 5*	TASK & SS
Camira	Stripes					•			95	CRIB 5	TASK & SS
Camira	Craggan						•		100	CRIB 5	TASK & SS
Camira	Code					•			85	CRIB 5*	TASK & SS
Camira	Century					•			77	CRIB 5	TASK & SS
CrestJTM	Contempo			•					0	CRIB 5	TASK & SS
CrestJTM	Shelly			•					0	CRIB 5	TASK & SS
CrestJTM	Vele				•				0	CRIB 5	TASK & SS
CrestJTM	Cambridge				•				0	CRIB 5	TASK & SS
CrestJTM	Colorado					•			0	CRIB 5	TASK & SS
Gabriel*	Chili		•						0	CRIB 5	TASK & SS
Yarwood	Dollar (vinyl)	•							0	CRIB 5	TASK & SS
Yarwood	Aneurin (vinyl)				•				0	CRIB 5	TASK & SS
Yarwood	Ascot (vinyl)				•				0	CRIB 5	TASK & SS
Yarwood	Churchill (vinyl)		•						0	CRIB 5	TASK & SS
Yarwood	Camden						•		0	CRIB 5	TASK & SS
Yarwood	Style						•		0	CRIB 5	TASK & SS
Yarwood	Hammersmith						•		0	CRIB 5	TASK & SS
Yarwood	Capri						•		0	CRIB 5	TASK & SS
Yarwood	Mustang						•		0	CRIB 5	TASK & SS

\* When treated

\* Featured swatches in previous fabric brand pages

**Please note:**

**Fabric bandings** Should your fabric of choice not be listed please contact our sales teams who will be happy to assist. The above is intended as a guide only. Please ensure you check the suitability of your selected fabric for its application prior to ordering.

**Leather** All leather fabrics are priced on application.

**Fabric swatches** We recommend that your final fabric selection is made based on a physical swatch only. Please note colour accuracy of printed fabric swatches is not guaranteed and is intended as a guide only.



# We are tcgroup

We're a bunch of product wizards, project superheroes, and operational dynamos, all teaming up to sprinkle some magic into your lives! We're all about bringing you the coolest furniture and accessories that will transform spaces into a playground of productivity and joy.

## 1990 – The beginning

TC Group was born from humble beginnings in 1990. Way back then, we were working from an office in Chew Magna, operating from a very small warehouse. Well, when we say 'office', we mean 'bungalow' and when we say 'warehouse' we mean 'pig shed.' Since then, we've been pretty busy.

## 2016 – Expansion

By 2016 both Titan and Woodstock Leabank joined the family bringing with them an additional 20 years of specialist experience, a whole load of colourful chairs and potential for so much more.

## 2025 – Looking ahead

We continue to innovate, grow and evolve but always retaining our core focus of customer-first. We employ over a hundred happy, knowledgeable and hardworking staff – each person is at the heart of our business.

**Join us on this fantastic journey of transformation, where dull and boring are banished forever. Let's create spaces people love!**

## Our values

### Aim high

We are **ambitious** and relentlessly seek to improve ideas and plans. We see the potential and **innovate** in situations where others do not.

### Do it together

We **listen, respect** and **value** each other's ideas and believe **teamwork** will produce the best results.

### Be responsible

We are **empowered** and **accountable** in our dealings with customers, suppliers and each other.

### Be authentic

We bring our **genuine** selves to work each day, building **trust** and **loyalty** with our teammates and customers.



# Your future fulfilment partner

We're here to help your business grow. We offer a talented team, and smart technology, to ensure you have the product selection, services and support to make your business stand out and succeed.

## Our services

- Frictionless Sales & After Sales
- Tender support
- Product training & support
- Bespoke marketing & promotions
- Space planning
- Delivery, installation & removal
- Bespoke product sourcing
- Stock management
- EDI with hourly stock feeds
- Daily shipped & back-order reporting



**100%**

of inbound calls answered



**100%**

of e-mails responded to in the same working day



**98%**

of phone calls answered within ten seconds



**+53**

NPS score – rated excellent by our customers in 2024



# Our operations

TC Group is a UK-based company with its UK headquarters in Bristol and European headquarters in Belfast. Our warehousing and QC teams are located in the Midlands, Belfast and Neuwied, Germany.

We also have an Asia office based in China, where specialist sourcing, quality control, and logistics teams work closely with our suppliers and customers to maintain high standards and ensure smooth operations.



## 4 warehouses

Coleshill, West Bromwich, Belfast and Neuwied



## 430,000 sq. ft

Warehouse footprint



## £15,000,000

Stockholding at retail prices



## 1,000,000+

Items shipped each year



## up to 1,000

Orders shipped daily



## 98.5%

On time in full OTIF



## 98.1%

20 week average product fill rate



## 2500

Delivery, Installation & Removal or Room of Choice deliveries monthly



## 24

Own vehicles & drivers

# Our website and portal

Not only have we freshened up our 2025 Directory to make it even easier to find the products you need quickly, we've also launched a new website to for those who prefer to browse and order online.

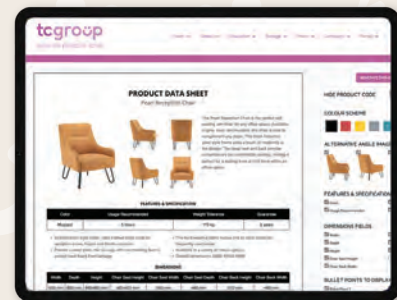
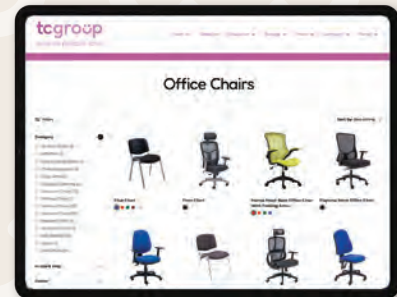
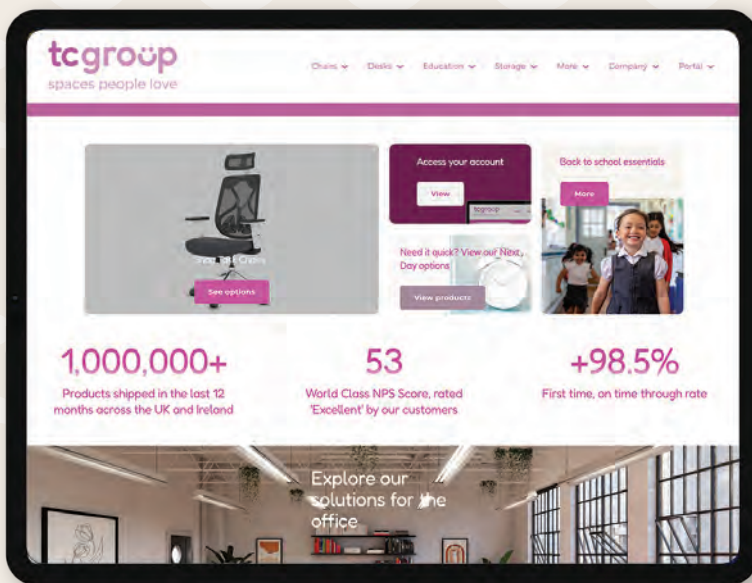

## Our new website delivers:

- Improved search and filter functions
- Image and data downloads
- Seamless integration with our Customer Portal to ensure you can keep track of everything with your TC dashboard 24/7

## Our portal enables you to:

- Create branded quotes and product data sheets
- Check stock levels
- View pricing
- Check delivery costs
- Track orders and view delivery status
- View invoices

## Are you signed up yet?

Our TC portal is built with you in mind and gives you 24/7 access to an amazing range of services!

Contact our Sales Team today to get set up and start using our fantastic features.



Email



# Spaces people love

## Commercial

TC Group offers more than 10,000 office furniture items across a wide range of categories, making it your ultimate destination for all your furniture needs.

From a single office desk to a complete office renovation, our team is readily available to provide professional guidance on your office furniture demands.

Supported by warranties and technical data, you can be confident we've got you covered.



## Collaborate

Creating collaborative spaces, perfect for project work and casual meetings in environments including:

- Commercial offices
- Libraries
- Community centres
- Higher Education establishments





## Education

Our collection of Titan Furniture comprises of more than 500 SKUs, which bring creativity and inspiration to educational settings globally, ensuring an exceptional learning experience for all students. As a worldwide designer, producer and supplier, we specialise solely in providing the sturdiest and superior quality classroom furniture.



## Focus

Providing spaces designed with technology and human performance at heart. Suitable for all environments including:

- Healthcare
- Commercial
- Higher Education

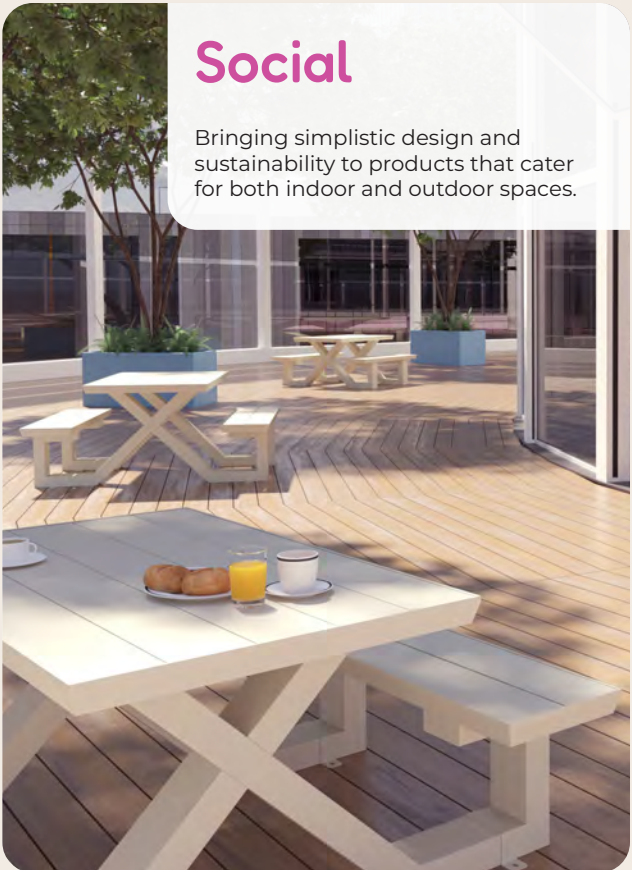

## Social

Bringing simplistic design and sustainability to products that cater for both indoor and outdoor spaces.

# Product ranges



## Seating

//01

How to choose the perfect office chair	6
Task Seating	8
24 Hour Seating	22
Posture Seating	32
Executive Seating	40
Meeting & Conference Seating	50
Operator Seating	66
Soft Seating	74



## Collections

//02

Café & Dining	94
Synergy Bench	118
Aztec Furniture	138
Core Furniture	164
Screens	180



## Desking & Tables //03

Meeting Tables	196
Reception Desking	214
Coffee Tables	220



## Booths & Pods //04

Lodge	226
Kuddle	230

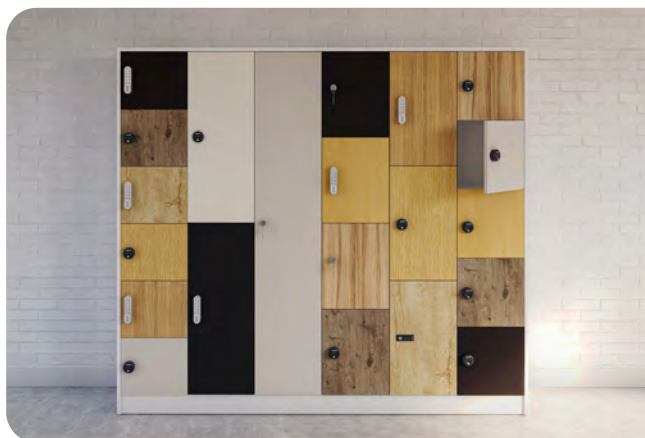

## Storage //05

Talos Steel Storage	244
Bisley	250
Lockers & Safes	266
Media Units	274



## Accessories //06

Power, Accessories & Coat Stands	280
----------------------------------	-----



## Education //07

Education	286
-----------	-----

# How to choose the perfect office chair

The right chair promotes good posture and comfort, enhances productivity and provides a happy and comfortable workforce. The average office chair can be in use for 1900 hours a year. Our selection of office seating ranges from Operator, through to Executive and Posture seating.



■ ..... **Support**  
Headrests offer neck and shoulder support

■ ..... **Material**  
A number of material options are available, from breathable mesh to luxury leather. We have something to suit every environment and budget

■ .....  
**Arms**  
Our arms can be fixed 1D, 2D, 3D or 4D depending on user preference. If you are a user that likes to adjust your seating position, 2D or 3D arms would be an ideal solution

■ .....  
**Adjustability**  
Do you need the back and seat to move independently, or is height adjustment alone sufficient? Think about the desired functionality when making your selection

■ .....  
**Seat pad**  
Our chairs feature a variety of seat pads. Consider the depth and width when making your selection, to ensure ultimate comfort



# Mechanism user guide



## Fixed back

- Seat moves up and down
- Back can be raised or lowered
- The backrest angle is fixed



## Permanent contact (PCB)

- Seat moves up and down
- Back can be raised or lowered
- Backrest angle can be fixed or set to free float i.e. in 'permanent contact' with your back



## Asynchro / Asynchro torsion

- Seat moves up and down
- Back can be raised or lowered
- Backrest angle can be fixed or set to free float
- Seat angle can be fixed to desired angle
- Torsion control knob can be adjusted to match body weight



## Lock tilt

- Seat moves up and down
- Tilt of chair can be locked or set to free float
- Torsion control knob can be adjusted to match body weight



## Synchro

- Seat moves up and down
- Backrest and seat angle can be fixed or set to free float (2:1 ratio)
- Synchro chairs can be fixed in either 3, 4 or 5 positions
- Torsion control knob can be adjusted to match body weight



## Knee tilt

- Seat moves up and down
- Backrest and seat angle can be fixed or set to free float (2:1 ratio)
- Knee tilt chairs can be fixed in either 3, 4 or 5 positions
- Torsion control knob can be adjusted to match body weight



## Ratchet back

- Back can be raised or lowered independently of chair functions



## Lumbar support

- Backrest provides support for the natural 'S' shape of the spine
- Prevents slumping and reduces stress on the spine and pelvis



## Seat slide

- Seat depth can be increased or decreased independently of chair functions

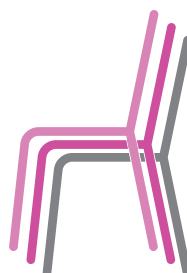

## Stacking chair

- Designed to be safely stacked
- Recommended number of chairs per stack is stated in product details if relevant

### Want to match your existing décor?

We offer an exciting unlimited fabrics service which allows you to choose your own fabric, and we'll do the rest. Look out for our unlimited fabrics icon on all products included in this service.



# Task Seating

// 01

Tired of uncomfortable seating? Our task seating collection offers ergonomic support and adjustable features to keep you comfortable throughout the day.



**Like this chair?**  
Shift chair (CH0756)  
in grey on page 11



**Shift**  
page 11



**Zip**  
page 11



**Maldini Family**  
pages 12-13



**Chachi**  
page 14



**Alto**  
page 15



**Denali Family**  
pages 16-17



**Start**  
page 18



**Carbon**  
page 18



**Vision**  
page 19



**Fonseca**  
page 19



**Marlos**  
page 20



**Spark**  
page 21



**Zico**  
page 21



**Like this chair?**  
Zip chair (CH0757)  
in black on page 11

# Shift

Fabric finish:

GR

Grey



Fully adjustable  
4D arms



**NEW**  
FOR 2025



- A stylish, modern task chair designed for optimal functionality
- Breathable mesh back and seat for enhanced comfort
- Available with fully adjustable 4D arms for personalised support
- Ideal for daily use in a range of commercial environments

## CH0756 // Shift

Overall	D650 W670 H995 - 1070
Seat	D415 W530 H450-530
Back	W745 H455
FR	Low
Fabric	Mesh
Mechanism	Wire control weight balance
Arms	4D Adjustable
RRP	£540.00

# Zip

Finishes:

BK

Black

GR

Grey



Folding arms



**NEW**  
FOR 2025



- Classic and comfortable task chair design for versatile use
- Breathable mesh back paired with soft, padded seat foam
- Convenient folding arms for easy storage
- Perfect for a variety of commercial environments

## CH0757 // Zip

Overall	D650 W665 H1115 - 1210
Seat	D505 W505 H475-575
Back	W460 H790
FR	Low
Fabric	Mesh / 100% Man-made
Mechanism	Lock tilt
Arms	Folding
RRP	£210.00



	CH0782 – Black frame / Black base	CH0782 – White frame / Chrome base
Overall	D690 W690 H1115-1245	D660 W660 H1130-1260
Seat	D475 W515 H420-520	D475 W515 H445-545
Back	W445 H680	W445 H680
FR	Low	Low
Fabric	Mesh / 100% Man-made	Mesh / 100% Man-made
Arms	1D adjustable	1D adjustable
Mechanism	Synchro 4 / Seat slide / Torsion	Synchro 4 / Seat slide / Torsion
RRP	£396.00	£396.00



# Maldini Family

Mesh finish | Fabric finishes | Frame/base finishes:



# Chachi



Fabric finish:



Black



**Adjustable headrest**  
ensuring user comfort and support

**Full breathable mesh**  
offering permanent contact across the entire back

**Black back**  
with hints of chrome,  
providing a contemporary look throughout the entire chair

**Adjustable black and chrome arms**  
offering both comfort and style

**Synchro 3 mechanism**  
with adjustable torsion control

**Chrome base**  
as standard providing a finished look

## CH1910 // Chachi

Overall	D730 W700 H1150 - 1325
Seat	D490 W500 H460 - 560
Back	W515 H730
FR	Low
Fabric	Mesh
Mechanism	Synchro 3 / Torsion
Arms	3D Adjustable
<b>RRP</b>	<b>£405.00</b>





# Alto

Fabric finish:

BK

Black



Breathable mesh high back and headrest allows breathability and provides full body support

1D adjustable arms included as standard

Synchro mechanism with integral torsion allows ultimate control based on the user's body weight

Seat slide adjustment

Black 5 star base



## CH1914 // Alto

Overall	D690 W690 H1120 - 1220
Seat	D480 W500 H455 - 555
Back	W470 H740
FR	Low
Fabric	Mesh
Mechanism	Synchro 4 / Torsion / Seat slide
Arms	1D Adjustable
RRP	£410.00





## Denali Mid Back

- A contemporary mid back mesh chair with black swivel base
- Supplied with black fixed arms

	<b>CH3301BK // Denali Black Mid Back</b>
Overall	D600 W620 H900 - 1000
Seat	D480 W480 H460 - 560
Back	W450 H505
FR	Low
Fabric	Mesh / 100% Man-made
Arms	Fixed
Mechanism	Synchro
<b>RRP</b>	<b>£189.00</b>



## Denali Visitor

- A contemporary mid back mesh chair
- Supplied with black fixed arms
- Chrome cantilever base and skid feet

	<b>CH3302BK // Denali Black Visitor</b>
Overall	D580 W600 H890
Seat	D480 W480 H460
Back	W450 H505
FR	Low
Fabric	Mesh / 100% Man-made
Arms	Fixed
<b>RRP</b>	<b>£189.00</b>

# Denali Family



Fabric finish:



- Height and tilt adjustable headrest for full body support
- Breathable mesh back helps support the contours of your back
- Supplied with 1D height adjustable arms
- Mesh backrest with adjustable lumbar support
- Synchro 4 mechanism with torsion control
- Black 5 star base

## Denali High Back

- A contemporary high back mesh chair with swivel base and built-in mesh headrest
- Supplied with height adjustable arms and built-in lumbar support

	<b>CH3300BK // Denali Black High Back</b>
Overall	D670 W590 H1200 - 1270
Seat	D500 W500 H480 - 550
Back	W480 H560
FR	Low
Fabric	Mesh / 100% Man-made
Arms	1D adjustable
Mechanism	Lock Tilt / torsion
RRP	£263.00



# Start



Fabric finish:

**BK**  
Black



- A mesh backed office chair with a chrome base, ideal for home offices
- Supplied with height adjustable arms
- Padded foam seat with textured covering

**CH1743 // Start**

Overall	D650 W650 H925 - 1015
Seat	D480 W480 H460 - 550
Back	W460 H560
FR	Low
Fabric	Mesh / 100% Man-made
Mechanism	Lock tilt / Torsion
Arms	1D Adjustable
<b>RRP</b>	<b>£162.00</b>

# Carbon



Fabric finish:

**BK**  
Black



- A low back office chair with unique folding arms
- Mesh back keeping you cool all day
- Black and silver base as standard

**CH1730 // Carbon**

Overall	D680 W680 H920 - 1000
Seat	D500 W500 H465 - 560
Back	W470 H570
FR	Low
Fabric	Mesh / 100% Man-made
Mechanism	PCB / Torsion
Arms	Folding
<b>RRP</b>	<b>£221.00</b>

# Vision

Fabric finish:

BK

Black



- A mesh backed chair with lumbar support, adjustable arms and a chrome base
- Well-padded fabric seat
- 2-lever multifunctional synchro-tilt mechanism
- Chrome 5 star base

## CH1010 // Vision

Overall	D640 W680 H1180 - 1260
Seat	D510 W510 H470 - 550
Back	W510 H630
FR	Low
Fabric	Mesh / 100% Man-made
Mechanism	Knee tilt / Torsion
Arms	2D Adjustable
RRP	£258.00

# Fonseca

Leather-look finish:

BK

Black



- A high back executive chair with a plush padded head rest and sides to hug the body
- Ample padding in seat to provide all-day comfort
- Supplied with black fixed arms and chrome base

## CH2404 // Fonseca

Overall	D700 W700 H1080 - 1180
Seat	D510 W510 H435 - 535
Back	W495 H755
FR	Med
Fabric	Mesh / leather-look
Mechanism	Lock tilt / Torsion
Arms	Fixed
RRP	£326.00

# Marlos



Fabric finishes:



Breathable mesh back helps support the contours of your back

Folding flip-up arms

Available in 5 colours

Black 5 star base

## CH0790 // Marlos

Overall	D670 W680 H970 - 1070
Seat	D490 W530 H435 - 535
Back	W495 H580
FR	Low
Fabric	Mesh / 100% Man-made
Mechanism	Lock tilt / Torsion
Arms	Folding
RRP	£232.00



# Spark

Stocked finish | Made to order finish:

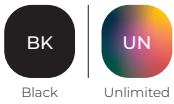

- Sliding seat as standard
- Modern design with a synchronous mechanism, a mesh back and 1D adjustable arms
- Black frame as standard

## CH0781 // Spark

Overall	D680 W680 H960 - 1090
Seat	D470 W490 H445 - 475
Back	W440 H665
FR	Low
Fabric	Mesh / 100% Man-made
Mechanism	Synchronous / Seat slide
Arms	1D Adjustable
RRP	£399.00

# Zico

Mesh finish | Frame finish:



- Supplied with fixed arms to match the frame
- Permanent contact mechanism with discreet levers, for a stylish and functional look
- Aluminium base

## CH0799 // Zico

Overall	D660 W660 H970 - 1065
Seat	D480 W460 H480 - 580
Back	W440 H665
FR	Low
Fabric	Mesh
Mechanism	PCB
Arms	Fixed
RRP	£337.00

# 24 Hour Seating

// 01

Need a chair that's always ready, no matter what? Our 24 hour seating is designed for comfort and endurance with a maximum 24 stone weight tolerance.



**Like this chair?**  
Bengal Mid Back chair (CH0741)  
in Gabriel Chili 63092 on page 24





**Bengal Headrest**  
page 24



**Bengal Mid Back**  
page 24



**Bengal High Back**  
page 25



**Fonz**  
page 26



**Strata**  
page 27



**Panther**  
page 28



**Cheetah**  
page 29



**Vista**  
page 30



**Call Centre**  
page 31



## Bengal High Back with Headrest

- Adjustable headrest supports the weight of your neck and shoulders
- Cold-moulded seat and foam high back
- Ratchet back to ensure users of various heights are comfortable and supported
- 3D adjustable arms ensure good posture and support throughout the duration of use
- Priced in Gabriel Chili, from which 13 colours are available

### CH0742 // Bengal High Back with Headrest

Overall	D710 W710 H1250 - 1380
Seat	D480 W480 H460 - 590
Back	W480 H630
FR	Med
Fabric	100% Man-made
Mechanism	Synchro / Ratchet back
Arms	3D Adjustable
<b>RRP</b>	<b>£855.00</b>



## Bengal Mid Back

- Cold-moulded seat and foam high back
- Ratchet back to ensure users of various heights are comfortable and supported
- 3D adjustable arms ensure good posture and support throughout the duration of use
- Priced in Gabriel Chili, from which 13 colours are available

### CH0741 // Bengal Mid Back

Overall	D710 W710 H965 - 1095
Seat	D480 W480 H460 - 590
Back	W445 H510
FR	Med
Fabric	100% Man-made
Mechanism	Synchro / Ratchet back
Arms	3D Adjustable
<b>RRP</b>	<b>£765.00</b>

# Bengal Family

Fabric finishes | Frame finishes:



**Ratchet back**  
to ensure users of various heights are comfortable and supported

**Cold-moulded seat and foam high back**

**3D arms**  
for multiple adjustment

**Synchro 4 mechanism**  
with torsion control

**Black 5 star base**

## Bengal High Back

<b>CH0740 // Bengal High Back</b>	
Overall	D710 W710 H1060 - 1190
Seat	D480 W480 H460 - 590
Back	W480 H630
FR	Med
Fabric	100% Man-made
Mechanism	Synchro / Ratchet back
Arms	3D Adjustable
<b>RRP</b>	<b>£790.00</b>



# Fonz

Fabric finish:

**BK**  
Black

- 5 YR Component Guarantee
- 2 YR Upholstery Guarantee
- 152 KG Weight Tolerance
- 24 Hours Usage

**PHYSIO APPROVED**

**24 STONE**  
**24 HOUR**



**Integral headrest**  
allows support for neck and shoulders

**Breathable floating back**  
design adds a modern twist with maximum comfort for 24 hours

**2D arms**  
included as standard

**Stylish grey base**  
that sets this chair apart from the usual office chair

**Sturdy synchro mechanism**  
with integrated torsion control allowing the user to adjust the chair according to their weight

<b>CH0730 // Fonz</b>	
Overall	D720 W720 H1150 - 1305
Seat	D460 W495 H480 - 570
Back	W495 H660
FR	Low
Fabric	Mesh / 100% Man-made
Mechanism	Synchro 3 / Torsion
Arms	2D Adjustable
<b>RRP</b>	<b>£572.00</b>



# Strata

Fabric finish:

**BK**  
Black

5 YR Component Guarantee

2 YR Upholstery Guarantee

152 KG Weight Tolerance

24 Hours Usage

PHYSIO APPROVED

24 STONE  
24 HOUR

GREENGUARD  
Indoor Air Quality Certified



Breathable mesh on high back chair

Fabric upholstered headrest that supports the weight of your neck and shoulders

Integral lumbar support ensuring full back support in an environment where it is most needed

Height adjustable arms included as standard, encouraging the correct seating position

Extra thick, foam seat provides ultimate comfort for all-day support

Integral seat slide which accommodates the taller user

Robust 24 hour mechanism with no less than 4 seat and back options, ensuring a durable and structurally stable chair

Greenguard tested to meet chemical emission requirements

<b>CH0735 // Strata</b>	
Overall	D700 W700 H1165 - 1285
Seat	D530 W520 H470 - 540
Back	W540 H685
FR	Low
Fabric	Mesh / 100% Man-made
Mechanism	Synchro 4 / Seat slide
Arms	1D Adjustable
RRP	£864.00



# Panther

Leather-faced finish | Fabric finishes:



**High ratchet back** with thick foam, boosting comfort levels throughout the day

**2D adjustable arms** included as standard, ensures good posture and support throughout the duration of use

**Thick-moulded seat** designed for lengthy use, comfort that goes the full distance

**Heavy duty mechanism** with independent controls allowing for maximum adjustability and flexibility

**Sturdy gas lift** built for 24 hour use, supporting up to 24 stone in weight

	CH1101 // Panther Leather	CH1108 // Panther Fabric
Overall	D660 W660 H1090 - 1260	D660 W660 H1090 - 1260
Seat	D530 W520 H460 - 550	D530 W520 H460 - 550
Back	W510 H630	W510 H630
FR	Low	Med
Fabric	Leather-faced	Wool mix
Mechanism	Asynchro / Torsion / Ratchet back	Asynchro / Torsion / Ratchet back
Arms	2D Adjustable	2D Adjustable
RRP	£731.00	£656.00



# Cheetah

Leather-faced finish | Fabric finish:

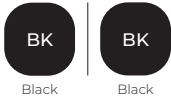

Neck high, ratchet back which offers permanent spine contact, promoting good posture

2D adjustable arms included as standard

Thick, luxurious seat pad for supreme comfort

Integral seat slide which accommodates the taller user

Heavy duty mechanism which is built for 24 hour use, supporting up to 24 stone in weight

Integrated torsion control allowing adjustment, based on the user's bodyweight



	CH1110 // Cheetah Leather	CH1111 // Cheetah Fabric
Overall	D660 W660 H1160 - 1280	D660 W660 H1160 - 1280
Seat	D480 W520 H510 - 590	D480 W520 H510 - 590
Back	W500 H720	W500 H720
FR	Low	Med
Fabric	Leather-faced	Wool mix
Mechanism	Asynchro / Torsion / Ratchet back / Seat slide	Asynchro / Torsion / Ratchet back / Seat slide
Arms	2D Adjustable	2D Adjustable
RRP	£803.00	£722.00



# Vista

Fabric finishes:



**Upholstered ratchet back** which moulds around the shape of the user's back, for comfort and support

**Inflatable lumbar support** allows the user to adjust levels of support

**2D adjustable arms** included as standard

**Heavy asynchro mechanism** allows the user to adjust the seat and back independently as required

**Integral torsion control** adjustable according to the user's weight

**Integral seat slide** allowing adjustment based on the height of the user

**Classic five star base**

## CH0903 // Vista

Overall	D680 W680 H1000 - 1160
Seat	D510 W520 H470 - 560
Back	W480 H570
FR	Med
Fabric	100% Man-made
Mechanism	Asynchro / Torsion / Ratchet back / Seat slide / Lumbar pump
Arms	2D Adjustable
<b>RRP</b>	<b>£570.00</b>





# Call Centre

Fabric finishes:



Thick-moulded back which enhances user support

Ratchet back to ensure users of various heights are comfortable and supported

2D adjustable arms included as standard, promoting good posture

Heavy duty mechanism with asynchro movements

Black five star base as standard

<b>CH0905 // Call Centre</b>	
Overall	D700 W700 H955 - 1115
Seat	D480 W480 H435 - 520
Back	W430 H540
FR	Med
Fabric	100% Man-made
Mechanism	Asynchro / Torsion / Ratchet back
Arms	2D Adjustable
<b>RRP</b>	<b>£510.00</b>



# Posture Seating

// 01

Looking for a chair that's perfectly tailored to you? Our posture seating is designed to promote healthy sitting, support your spine, encourage proper alignment, and improve circulation.



**Like this chair?**  
Bearing chair (CH2003)  
found on page 35



**Aspect**  
page 34



**Bearing**  
page 35



**Maxi Ergo**  
page 36



**Mode**  
page 37



**Calypso Ergo**  
page 38



**Concept Plus**  
page 39

# Aspect

Fabric finishes:

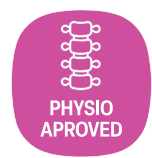

**Ratchet height adjustable backrest**  
allows the user to increase the height of the backrest with a simple click-lift system

**Fully upholstered tri-curved posture backrest spine**, shaped to perfectly fit the contours of your back with integrated thoracic support for optimum comfort

**Ergonomic armrests** with height and depth adjustment features to support the arms in a relaxed or working position

**Inflatable lumbar support** for extra support in the lower back, adding adjustable comfort

**Flex-front deep cushioned posture seat** with ergo density moulded foam for maximum user comfort

**Seat slide adjustment** with 75mm of travel to increase the depth of the seat for the user with longer legs

**Ergonomic body-balance synchro mechanism**  
Auto responsive, in harmony with natural body movements in free float mode and with 5 lockable positions

**Simplistic controls**  
Single lever operation for tilt release, tilt lock and seat height

**Black 5 star pyramid base** with 60mm castors for ease of mobility

	<b>CH2001 // Aspect</b>
Overall	D685 W685 H1030 - 1200
Seat	D460 W500 H470 - 570
Back	W430 H560
FR	Med
Fabric	100% Man-made
Mechanism	Synchro / Seat slide / Lumbar pump / Ratchet back / Tension control
Arms	2D Adjustable
<b>RRP</b>	<b>£675.00</b>



# Bearing

Fabric finish:



\*Unlimited



**Ratchet height adjustable backrest** allows the user to increase the height of the backrest with a simple click-lift system

**Fully upholstered tri-curved posture backrest spine**, shaped to perfectly fit the contours of your back with integrated thoracic support for optimum comfort

**Inflatable lumbar support** form extra support in the lower back, adding adjustable comfort

**Flex-front deep cushioned posture seat** with ergo density moulded foam and adaptive front edge seat flex for maximum user comfort

**Back angle adjustment**

**Synchronised adjustment** 2:1 ratio with anti-shock release

**Seat angle adjustment** for added comfort

**Body weight tension control and seat slide**

**Seat height adjustment**



	<b>CH2003 // Bearing</b>
Overall	D685 W685 H1060 - 1250
Seat	D470 W500 H480 - 590
Back	W450 H580
FR	Med
Fabric	100% Man-made
Mechanism	Synchro / Seat slide / Lumbar pump / Ratchet back / Tension control
Arms	2D Adjustable
<b>RRP</b>	<b>£1,104.00</b>



# Maxi Ergo

Fabric finishes:



**Ratchet height adjustable backrest** allows the user to increase the height of the backrest with a simple click-lift system



Shown with optional folding arms



**Inflatable lumbar pump** for extra support



**Flex-front deep cushioned** posture seat with ergo density moulded foam and adaptive front edge seat flex for maximum user comfort



**Seat slide adjustment** with 75mm of travel to increase the depth of the seat for the user with longer legs



**Asynchro mechanism** for independent functionality that adjusts to the user's weight, with integral torsion control



Codes	CH0808 // Maxi Ergo	£457.00
	CH0808 + AC1002 // Maxi Ergo + Fixed Arms	£510.00
	CH0808 + AC1040 // Maxi Ergo + 1D Adjustable Arms	£523.00
	CH0808 + AC1082 // Maxi Ergo + Folding Arms	£560.00
Overall	D680 W680 H1070 - 1270	
Seat	D500 W520 H490 - 620	
Back	W500 H600	
FR	Med	
Fabric	100% Man-made	
Mechanism	Asynchro / Torsion / Seat slide / Ratchet back / Lumbar pump	



# Mode

Fabric finishes:



**Slimline mesh backrest** allows breathability and support for the contours of your back

**Fixed height backrest** with adjustable lumbar panel for extra support in the lower back

**Seat slide adjustment** with 75mm of travel to increase the depth of the seat for the user with longer legs

**Simplistic controls** with single lever operation for tilt release, tilt lock and seat height

**Ergonomic armrests** with height and depth adjustment features to support the arms in a relaxed or working position

**Flex-front deep cushioned posture seat** with ergo density moulded foam for maximum user comfort

**Ergonomic body-balance synchro mechanism** harmonises with natural body movements in free float mode and with 5 lockable positions

**Black 5 star pyramid base** with 60mm castors for ease of mobility



	<b>CH2002 // Mode</b>
Overall	D685 W685 H1010 - 1110
Seat	D460 W500 H470 - 570
Back	W450 H540
FR	Low
Fabric	100% Man-made
Mechanism	Synchro / Seat slide / Lumbar / Tension control
Arms	2D Adjustable
<b>RRP</b>	<b>£675.00</b>



# Calypso Ergo

Fabric finishes | PU Finish:

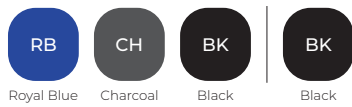

PCB (permanent contact back) mechanism which provides constant support wherever you move

Curved back rest for permanent contact and support

Shown with optional 1D adjustable arms

Inflatable lumbar pump for extra support

Deep cushioned seat and back upholstered in a hard wearing fabric

Codes	CH2810 // Calypso Ergo	£211.00
	CH2810 + AC1040 // Calypso Ergo + 1D Adjustable Arms	£274.00
	CH2810 + AC1082 // Calypso Ergo + Folding Arms	£292.00
Overall	D640 W640 H990 - 1160	
Seat	D440 W460 H470 - 595	
Back	W445 H495	
FR	Med	
Fabric	100% Man-made	
Mechanism	PCB / Lumbar pump	





# Concept Plus

Fabric finishes:



<b>CH1808 // Concept Plus</b>	
Overall	D630 W675 H1035 - 1230
Seat	D470 W510 H470 - 590
Back	W480 H580
FR	Low
Fabric	100% Man-made
Mechanism	Asynchro / Torsion / Seat slide / Ratchet back / Lumbar pump
Arms	1D Adjustable
<b>RRP</b>	<b>£414.00</b>



# Executive Seating

// 01

Our executive seating collection is designed for those who want both style and support. Perfect for powering through long meetings, back-to-back calls, or focused work sessions.



**Like this chair?**  
Dawn Mid Back chair (CH4202)  
found on page 42



**Dawn Mid Back**  
page 42



**Dawn Visitor**  
page 42



**Dawn High Back**  
page 43



**Ares**  
page 44



**Montana**  
page 45



**Keno**  
page 46



**Puma**  
page 46



**Fleck**  
page 47



**Jack Family**  
page 48



**Canasta Family**  
page 49



## Dawn Mid Back

- Contemporary and elegant design for a sophisticated look
- Ideal for executive offices, meeting rooms, and conference spaces
- Features sleek aluminium armrests and a chrome 5 star base with plush cushioning for comfort
- Available upholstered in brown or black PU for a luxurious finish
- Ribbed effect on the seat back for a stylish touch

	CH4202 // Dawn Mid Back Black	CH4202 // Dawn Mid Back Brown
Overall	D575 W625 H955 - 1050	D575 W625 H955 - 1050
Seat	D530 W520 H430 - 510	D530 W520 H430 - 510
Back	W480 H660	W480 H660
FR	Med	Med
Fabric	Leather-look	Leather-look
Mechanism	Synchro 1 / Torsion	Synchro 1 / Torsion
Arms	Fixed	Fixed
RRP	£385.00	£355.00



## Dawn Visitor

- Contemporary and elegant design for a sophisticated look
- Ideal for executive offices, meeting rooms and conference spaces
- Features sleek aluminium armrests and a chrome cantilever base with plush cushioning for comfort
- Available upholstered in brown or black PU for a luxurious finish
- Ribbed effect on the seat back for a stylish touch

	CH4203 // Dawn Cantilever Black	CH4203 // Dawn Cantilever Brown
Overall	D565 W640 H1000	D565 W640 H1000
Seat	D510 W535 H515	D510 W535 H515
Back	W490 H670	W490 H670
FR	Med	Med
Fabric	Leather-look	Leather-look
Arms	Fixed	Fixed
RRP	£385.00	£355.00

# Dawn Family

Leather-look finishes:

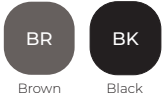

## Dawn High Back

	CH4201 // Dawn High Back Black	CH4201 // Dawn High Back Brown
Overall	D650 W625 H1175 - 1270	D650 W625 H1175 - 1270
Seat	D515 W525 H440 - 520	D515 W525 H440 - 520
Back	W480 H890	W480 H890
FR	Med	Med
Fabric	Leather-look	Leather-look
Mechanism	Synchro 1 / Torsion	Synchro 1 / Torsion
Arms	Fixed	Fixed
RRP	£385.00	£355.00



# Ares

Leather-look finish:

**BK**  
Black



<b>CH0270 // Ares</b>	
Overall	D690 W690 H1145 - 1200
Seat	D530 W530 H495 - 550
Back	W530 H770
FR	Low
Fabric	Leather-look
Mechanism	Knee-tilt / Torsion
Arms	Fixed
<b>RRP</b>	<b>£438.00</b>



E&OE. All items are subject to VAT, where applicable.

# Montana

Leather-look finish:

**BK**  
Black



**Padded headrest**  
ensuring user comfort

**Padded armrest**

**Leather-look**  
premium grade  
executive office  
chair

**Generously cushioned**  
seat and back

**Knee-tilt mechanism**  
can be fixed in four  
different positions

**Chrome base**  
as standard providing  
a polished look

<b>CH0240 // Montana</b>	
Overall	D720 W720 H1150 - 1230
Seat	D540 W525 H515 - 595
Back	W530 H730
FR	Low
Fabric	Leather-look
Mechanism	Knee-tilt / Torsion
Arms	Fixed
<b>RRP</b>	<b>£586.00</b>



# Keno

Fabric finish:

CH  
Charcoal



- Generously upholstered executive style in hard wearing fabric
- Black nylon base with twin wheel hooded castors
- Lock tilt mechanism which is lockable in the upright position

## CH0137 // Keno

Overall	D690 W690 H1130 - 1230
Seat	D530 W535 H480 - 580
Back	W550 H770
FR	Low
Fabric	100% Man-made
Mechanism	Lock tilt / Torsion
Arms	Fixed
RRP	£266.00



# Puma

Leather-look finish:

BK  
Black



- Generously padded seat and back with a chrome base and height adjustable arms
- Curved leather-look back to promote good posture and hug the user

## CH1003 // Puma

Overall	D620 W620 H1000 - 1180
Seat	D450 W460 H490 - 620
Back	W440 H490
FR	Low
Fabric	Leather-look
Mechanism	PCB
Arms	1D Adjustable
RRP	£264.00





# Fleck

Leather-look finish:



Black



<b>CH1665 // Fleck</b>	
Overall	W560 D635 H985-1065
Seat	W470 D480 H410 - 490
Back	W500 H630
FR	Low
Fabric	Leather-look
Mechanism	Lock tilt / Torsion
Arms	Fixed
<b>RRP</b>	<b>£195.00</b>



# Jack Family

Leather-look finish | Fabric finish:

- BK  
Black
- CH  
Charcoal

**2 YR**  
Component  
Guarantee

**2 YR**  
Upholstery  
Guarantee

**115 KG**  
Weight  
Tolerance

**8**  
Hours  
Usage



Professional looking executive chair with fixed arms

Lock tilt mechanism which is lockable in the upright position

Black nylon swivel base with twin wheel hooded castors



## Jack

<b>CH1765 // Jack</b>	
Overall	D600 W620 H1020 - 1135
Seat	D480 W500 H440 - 555
Back	W500 H630
FR	Low
Fabric	Leather-look
Mechanism	Lock tilt / Torsion
Arms	Fixed
<b>RRP</b>	<b>£177.00</b>

## Jack Fabric

<b>CH1765CH // Jack Fabric</b>	
Overall	D600 W620 H1020 - 1135
Seat	D480 W500 H440 - 555
Back	W500 H630
FR	Low
Fabric	100% Man-made
Mechanism	Lock tilt / Torsion
Arms	Fixed
<b>RRP</b>	<b>£177.00</b>

E&OE. All items are subject to VAT, where applicable.

# Canasta Family

Leather-look finish:



Black



High back leather-look executive chair with a swivel base and fixed arms

Stylish stitching detail on seat and back

Tension control knob which can be adjusted to match the user's bodyweight

## Canasta High Back

<b>CH0768 // Canasta High Back</b>	
Overall	D720 W650 H1050 - 1145
Seat	D510 W520 H475 - 570
Back	W520 H710
FR	Low
Fabric	Leather-look
Mechanism	Lock tilt / Torsion
Arms	Fixed
<b>RRP</b>	<b>£235.00</b>

## Canasta Visitor

<b>CH0766 // Canasta Visitor</b>	
Overall	D635 W610 H975
Seat	D510 W490 H465
Back	W490 H580
FR	Low
Fabric	Leather-look
Arms	Fixed
<b>RRP</b>	<b>£235.00</b>



# Meeting & Conference

// 01

Bored of bland meeting rooms? Time to upgrade! Our collection has everything from stylish chairs with chrome frames and leather finishes to custom-upholstered seating.



**Like this chair?**  
Fleck (CH1665) can  
be found on page 57



**Faze**  
page 54



**Guise**  
page 55



**Sosa**  
page 56



**Fleck**  
page 57



**Twilight**  
page 58



**Veer**  
page 59



**Summit Meeting**  
page 59



**Jupiter Family**  
page 60



**Florence Family**  
page 60



**Pavia**  
page 61



**Pavilion**  
page 61



**Renoir Family**  
page 62



**Banqueting**  
page 62



**Club Family & Accessories**  
page 63



**Folding Chairs & Trolley**  
page 64



**Arc High Density Stacker & Trolley**  
page 65



# Stem

Introducing Stem – the chair that effortlessly blends style and comfort!

Perfect for your home, office, or any space craving a fresh, modern upgrade. Stem is here to elevate your seating game.

With three stylish wood finishes and nine contemporary plastic finishes to choose from, you can easily find the perfect match for you.

These lightweight chairs are a breeze to move around, stackable up to 40 high, and can be easily stored out of the way. For added convenience, a trolley is also available, making transportation and setup even easier for any occasion, from casual hangouts to conference sessions.



Contact us for  
more information



# Deco

Welcome to Deco, where style and comfort are the ultimate dream team! Deco is here to transform your space with a touch of modern flair and a whole lot of cosiness.

Whether you're sprucing up a lively lounge or adding some extra charm to a sleek boardroom, Deco's fresh and versatile design fits right in.

Available in both armchair and side chair designs, with seven distinct frame options - including sleek 4 leg wooden and metal styles, a cantilever, a swivel, smooth glide, and bar stool designs - Deco offers you the freedom to create the ideal aesthetic that blends seamlessly with space.



  
Contact us for  
more information

# Faze

Fabric finishes:



Soft seat and back for a sleek design

Winged arms for added comfort and style

Self-correcting mechanism for enhanced functionality

4 leg steel spider base ensuring stability

Black painted legs



## OF0604 // Faze

Overall	W580 D605 H865
Seat	W420 D400 H485
Back	W490 H520
FR	Med
Fabric	100% Man-made
RRP	£295.00





# Guise

Fabric finishes:



<b>OF0605 // Guise</b>	
Overall	W515 D565 H860
Seat	W410 D440 H480
Back	W480 H40
FR	Med
Fabric	100% Man-made
RRP	£270.00



# Sosa

Leather-look finish:

**BK**  
Black



<b>CH2249 // Sosa</b>	
Overall	W700 D700 H900 - 1000
Seat	W500 D500 H420 - 520
Back	W500 H500
FR	Low
Fabric	Leather-look
Mechanism	Lock tilt / Torsion
Arms	Fixed
<b>RRP</b>	<b>£294.00</b>



# Fleck

Leather-look finish:



BK

Black



## CH1665 // Fleck

Overall	W560 D635 H985-1065
Seat	W470 D480 H410 - 490
Back	W500 H630
FR	Low
Fabric	Leather-look
Mechanism	Lock tilt / Torsion
Arms	Fixed
RRP	£195.00



# Twilight

Polypropylene finish:

**BK**  
Black

25  
Stacks up to  
25 high

5 YR  
Component  
Guarantee

2 YR  
Upholstery  
Guarantee

115 KG  
Weight  
Tolerance

8  
Hours  
Usage



## CH0507 // Twilight Stacker Chair

Overall W440 D490 H755  
 Seat W425 D435 H435  
 Back W460 H245  
 FR Low  
 Fabric Polypropylene  
 Storage Stacks 25  
**RRP £218.00**

## AC0508 // Twilight Trolley

**RRP £479.00**

# Twilight Writing Tablet

Polypropylene finish:

**BK**  
Black

2 YR  
Component  
Guarantee

2 YR  
Upholstery  
Guarantee

115 KG  
Weight  
Tolerance

8  
Hours  
Usage



· Folding, adjustable arm tablet

## CH0507 + AC0507 // Twilight with Writing Tablet

Overall W440 D490 H755  
 Seat W425 D435 H435  
 Back W460 H245  
 FR Low  
 Fabric Polypropylene  
**RRP £307.00**

# Veer

Leather-look finish:

**BK**  
Black



**NEW**  
FOR 2025

- Smooth-rolling, non-lockable castors for easy movement
- Black PVC seat and back complemented by a slender, black-painted spider base

### CH0629 // Veer

Overall	W440 D555 H790
Seat	W440 D380 H450
Back	W420 H400
FR	Low
Fabric	Leather-look
RRP	£120.00

# Summit Meeting

Fabric finish:

**CH**  
Charcoal



- Cushioned seat and back for added comfort
- Chrome cantilever frame

### CH0501 // Summit Meeting Chair

Overall	W500 D565 H810
Seat	W500 D500 H480
Back	W490 H270
FR	Low
Fabric	100% Man-made
Storage	Stacks 4
RRP	£204.00

# Jupiter Family



Fabric finish:

**BK**  
Black

**Mesh back** allows air to circulate, keeping users cool and comfortable, especially during long meetings

**Plastic skid feet** for stability and to avoid floor marking



**Chrome frame** provides a sleek look that can enhance the overall appearance of a meeting room

## Side Chair

### CH0785 // Jupiter Side Chair

Overall	W460 D530 H830
Seat	W460 D460 H485
Back	W450 H275
FR	Low
Fabric	100% Man-made
Storage	Stacks 4
<b>RRP</b>	<b>£161.00</b>

## Armchair

### CH0784 // Jupiter Armchair

Overall	W530 D560 H830
Seat	W460 D470 H485
Back	W450 H275
FR	Low
Fabric	100% Man-made
Arms	Fixed
Storage	Stacks 4
<b>RRP</b>	<b>£172.00</b>

# Florence Family



Stocked finish | Made to order finish:

**BK**  
Black

**UN**  
Unlimited

**Plastic skid feet** for stability and to avoid floor marking

**Integral arms** offer consistent and reliable support



**Black frame** ensures these chairs look great in any meeting room

## Side Chair

### CH3510 // Florence Side Chair

Overall	W620 D550 H840
Seat	W480 D500 H480
Back	W450 H350
FR	Med
Fabric	100% Man-made
Storage	Stacks 4
<b>RRP</b>	<b>£175.00</b>

## Armchair

### CH3508 // Florence Armchair

Overall	W620 D550 H840
Seat	W480 D500 H480
Back	W450 H350
FR	Med
Fabric	100% Man-made
Arms	Fixed
Storage	Stacks 4
<b>RRP</b>	<b>£189.00</b>

# Pavia

Leather-look finish:



- Professional looking visitor chairs to suit any office space
- Stylish chrome cantilever base with skid feet

## CH2235 // Pavia

Overall	W600 D570 H890
Seat	W465 D445 H470
Back	W465 H430
FR	Low
Fabric	Leather-look
Arms	Fixed
Storage	Stacks 4
RRP	£262.00

# Pavilion Armchair

Leather-look finish:

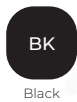

- Sturdy chrome frame
- Plastic skid feet for stability and to avoid floor marking
- Leather-look

## CH0529 // Pavilion Armchair

Overall	W570 D640 H840
Seat	W480 D480 H480
Back	W470 H400
FR	Low
Fabric	Leather-look
Storage	Stacks 3
Arms	Fixed
RRP	£270.00

# Renoir Family



Fabric finishes:

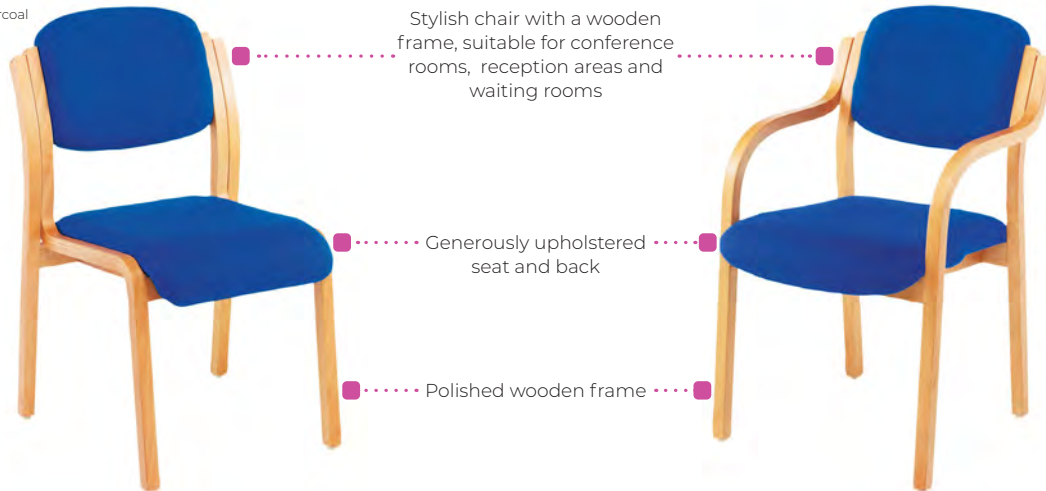

## Renoir Side Chair

<b>CH0705 // Renoir Side Chair</b>	
Overall	W515 D590 H840
Seat	W410 D490 H465
Back	W400 H295
FR	Med
Fabric	100% Man-made
Storage	Stacks 4
<b>RRP</b>	<b>£176.00</b>

## Renoir Armchair

<b>CH0706 // Renoir Armchair</b>	
Overall	W520 D610 H850
Seat	W465 D485 H465
Back	W400 H295
FR	Med
Fabric	100% Man-made
Arms	Fixed
Storage	Stacks 4
<b>RRP</b>	<b>£185.00</b>

# Banqueting



Fabric finishes:



- High fabric back with handle to aid easy setup and movement
- Powder-coated black metal frame

<b>CH0519 // Banqueting</b>	
Overall	W440 D580 H850
Seat	W400 D390 H470
Back	W325 H300
FR	Med
Fabric	100% Man-made
Storage	Stacks 4
<b>RRP</b>	<b>£118.00</b>



# Club Family

Fabric finishes | PU finishes:

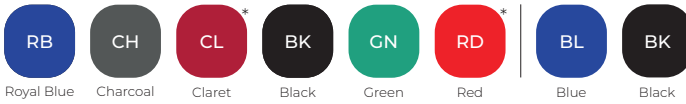

\* Not available with chrome frame

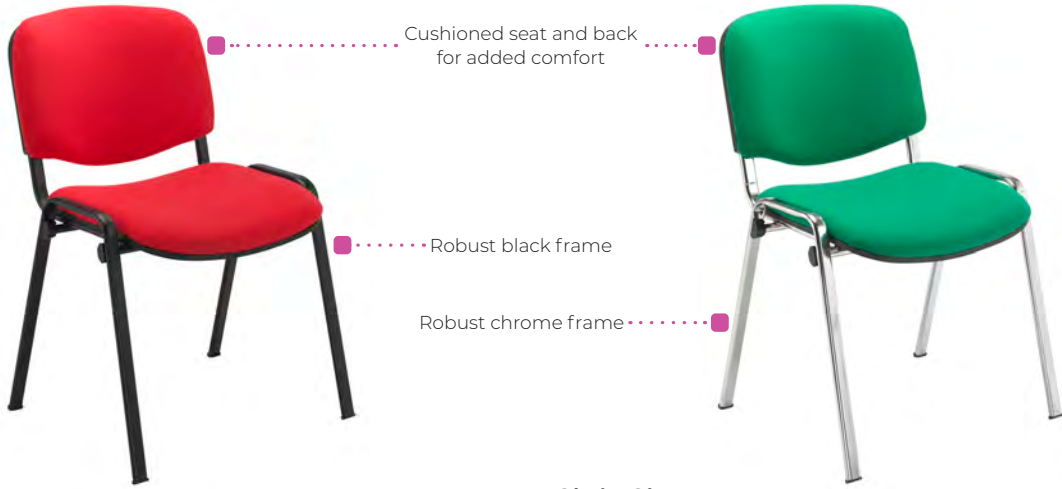

## Club

	CH0500 // Club	CH0500PU // Club PU
Overall	W530 D610 H810	W530 D610 H810
Seat	W470 D415 H465	W470 D415 H465
Back	W470 H335	W470 H335
FR	Med	Med
Fabric	100% Man-made	Leather-look
Storage	Stacks 4	Stacks 4
RRP	£89.00	£94.00

## Club Chrome

	CH0503 // Club Chrome	CH0503PU // Club Chrome PU
Overall	W530 D610 H810	W530 D610 H810
Seat	W470 D415 H465	W470 D415 H465
Back	W470 H335	W470 H335
FR	Med	Med
Fabric	100% Man-made	Leather-look
Storage	Stacks 4	Stacks 4
RRP	£98.00	£103.00

Polypropylene finishes:

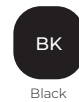

## Club Arms

Code	Description	RRP
AC1054	Club arms - sold as pairs	£43.00



## Club Canteen

	CH0506 // Club Canteen
Overall	W530 D610 H805
Seat	D390 W460 H435
Back	W460 H320
FR	Low
Fabric	Polypropylene
Storage	Stacks 8
RRP	£86.00

## Universal Plastic Tablet

Code	Description	RRP
AC1055	Universal plastic tablet - sold as singles	£71.00

# Folding Chairs



Finishes:



Blue



Charcoal



Burgundy



## Flat Back Folding Chair

TCFLFC // Flat Back Folding Chair

Overall	W450 D520 H810
Seat	W295 D295 H450
Back	W395 H160
FR	Low
Fabric	Polypropylene



## Fan Back Folding Chair

TCFAFC2LK // Fan Back Folding Chair

Overall	W470 D560 H900
Seat	W395 D400 H470
Back	W410 H250
FR	Low
Fabric	Polypropylene

# Folding Chair Trolley

Finish:



Black



- Easy to control with two swivel and two fixed castors
- Simple assembly

Code	Dimensions
TC40T // 40 Capacity Trolley	W1267 D600 H473
TC70T // 70 Capacity Trolley	W1750 D790 H1100
TC140T // 140 Capacity Trolley	W1750 D790 H2250

# Arc High Density



Seat finishes:



**Trolley**

	<b>TA17TROLLEY // Arc High Density Trolley</b>
Overall	W620 D890 H850
FR	Low
Material	Polypropylene



**Stacker Chair**

	<b>TA17 // Arc High Density Stacker Chair</b>	<b>TA17LINK // Arc High Density Linking Clip   Black</b>
Overall	W510 D460 H 805	
Seat	W425 D400 H455	
Back	W420 H285	
FR	Low	
Material	Polypropylene	
Storage	Stacks up to 40 high	<b>TA17SPUN // Arc High Density Stacker Seat Pad</b>



**Like this chair?**  
 Arc High Density Stacker chair (TA17) shown with optional seat pad

# Operator Seating

// 01

Ready to conquer your workday? Our operator seating collection is perfect for extended hours at your desk, offering comfort and support for focused productivity. Ideal for call centres and task-oriented environments.



**Like this chair?**  
Calypso Mesh chair (CH2803)  
in black can be found on page 71

**Concept Family**



Mid Back  
page 68



High Fixed  
page 68



Height Adjustable  
page 68



Deluxe  
page 69



High Back  
page 69

**Versi**



Versi High Back  
page 70

**Calypso Family**



Deluxe  
page 71



High Back  
page 71



Mesh  
page 71

**Factory Family**



1 Lever  
page 72



2 Lever  
page 72



High Fixed  
page 72



2 Lever Adjustable  
page 72

**Arms & Accessories**



Chair Arms  
page 73



Accessories  
page 73



### Concept Mid Back

- Deep cushioned seat and back upholstered in a hard wearing fabric
- Backrest angle can be fixed or set to free float with the user

<b>CH0803 // Concept MB</b>	
Overall	D630 W630 H840 - 1060
Seat	D470 W490 H460 - 585
Back	W420 H410
FR	Med
Fabric	100% Man-made
Mechanism	PCB
<b>RRP</b>	<b>£254.00</b>

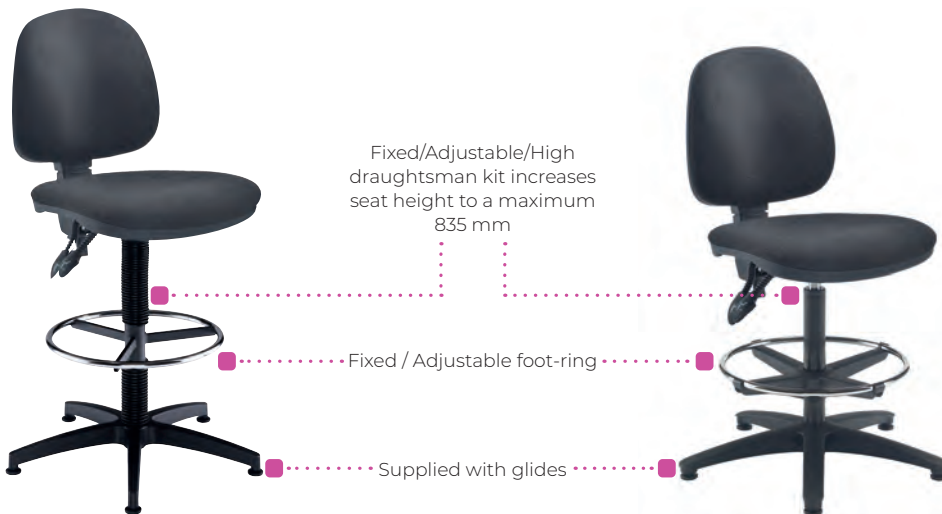

### Concept High Fixed

<b>CH0803 + AC1014 // Concept High MB D-Kit Fixed</b>	
Overall	D700 W700 H840 - 970
Seat	D475 W470 H705 - 835
Back	W420 H400
FR	Med
Fabric	100% Man-made
Mechanism	PCB
<b>RRP</b>	<b>£350.00</b>

### Concept Height Adjustable

<b>CH0803 + AC1042 // Concept High MB Height Adjustable D-Kit</b>	
Overall	D700 W700 H840 - 970
Seat	D475 W470 H705 - 835
Back	W420 H400
FR	Med
Fabric	100% Man-made
Mechanism	PCB
<b>RRP</b>	<b>£354.00</b>

# Concept Family

Fabric finishes:



Royal Blue Charcoal



## Concept Deluxe

- Deep cushioned seat and back upholstered in a hard wearing fabric
- Asynchro mechanism allows each user to adapt the chair to their needs

**CH0801 // Concept Deluxe**

Overall	D630 W630 H965 - 1090
Seat	D460 W490 H455 - 580
Back	W445 H510
FR	Med
Fabric	100% Man-made
Mechanism	Asynchro
<b>RRP</b>	<b>£268.00</b>



## Concept High Back

- Deep cushioned seat and back upholstered in a hard wearing fabric
- Backrest angle can be fixed or set to free float with the user

**CH0802 // Concept HB**

Overall	D630 W630 H965 - 1090
Seat	D460 W475 H445 - 580
Back	W445 H495
FR	Med
Fabric	100% Man-made
Mechanism	PCB
<b>RRP</b>	<b>£255.00</b>

# Versi

Fabric finishes:



Royal Blue Charcoal Black



## Versi

- Modern design with a rounded back for lumbar and back support
- Two level controls for seat height and tilt adjustments
- Optional arms available

### CH0001 // Versi

Seat	D450 W460 H475 - 610
Back	W440 H490
FR	Med
Fabric	100% Man-made
Mechanism	PCB
<b>RRP</b>	<b>£143.00</b>



## Versi Fixed Arm

### CH0001 + AC0001FA // Versi Fixed Arms

Seat	D450 W460 H475 - 610
Back	W440 H490
FR	Med
Fabric	100% Man-made
Mechanism	PCB
Arms	Fixed
<b>RRP</b>	<b>£172.00</b>

## Versi Adjustable Arm

### CH0001 + AC0002AA // Versi 1D Adjustable Arms

Seat	D450 W460 H475 - 610
Back	W440 H490
FR	Med
Fabric	100% Man-made
Mechanism	PCB
Arms	1D Adjustable
<b>RRP</b>	<b>£180.00</b>



# Calypso Family

Fabric finishes | PU Finish:



**FOR ARM OPTIONS**  
page 73



Asynchro mechanism for independent adjustment of height, back and seat angle



## Calypso Deluxe

- Asynchro mechanism allows independent adjustment of height, back and seat angle
- Backrest angle can be fixed or free to float with the user
- Arms can be added to any of the Calypso chairs

	CH2801PU // Calypso High Back Deluxe PU	CH2801 // Calypso High Back Deluxe
Overall	D650 W650 H990 - 1175	D650 W650 H990 - 1175
Seat	D450 W450 H475 - 610	D450 W450 H475 - 610
Back	W445 H490	W445 H490
FR	Med	Med
Fabric	100% Man-made	100% Man-made
Mechanism	Asynchro	Asynchro
RRP	£217.00	£210.00



Deep cushioned seat and back upholstered in a hard wearing fabric

Permanent contact back (PCB) ensures user comfort for up to eight hours

Shown with optional folding arms

Backrest angle can be fixed or free to float with the user



Black mesh as standard

Shown with optional 1D adjustable arms

## Calypso High Back

	CH2800 // Calypso High Back	CH2800PU // Calypso High Back PU
Overall	D650 W650 H985 - 1175	D650 W650 H985 - 1175
Seat	D450 W460 H475 - 610	D450 W460 H475 - 610
Back	W440 H490	W440 H490
FR	Med	Med
Fabric	100% Man-made	100% Man-made
Mechanism	PCB	PCB
RRP	£172.00	£191.00

## Calypso Mesh

	CH2803 // Calypso Mesh
Overall	D650 W650 H1010 - 1175
Seat	D450 W460 H475 - 600
Back	W415 H540
FR	Low
Fabric	Mesh / 100% Man-made
Mechanism	PCB
RRP	£253.00

# Factory Family



Polyurethane seat finish:



Black



## Factory

<b>CH0504 // Factory</b>	
Overall	D600 W600 H840 - 990
Seat	D435 W465 H475 - 585
Back	W415 H305
FR	Low
Fabric	Polyurethane
Mechanism	Fixed
<b>RRP</b>	<b>£209.00</b>

## Factory 2 Lever

<b>CH0505 // Factory 2 Lever</b>	
Overall	D600 W600 H915 - 1045
Seat	D435 W465 H445 - 575
Back	W415 H305
FR	Low
Fabric	Polyurethane
Mechanism	PCB
<b>RRP</b>	<b>£243.00</b>



## Factory High Fixed

	<b>CH0504 + AC1014 // Factory High Fixed + Static Foot Ring</b>	<b>CH0504 + AC1042 // Factory Height Adjustable + Adjustable Foot Ring</b>
Overall	D600 W600 H985 - 1125	D600 W600 H950 - 1210
Seat	D440 W470 H715 - 830	D455 W465 H575 - 825
Back	W410 H310	W415 H305
FR	Low	Low
Fabric	Polyurethane	Polyurethane
Mechanism	Fixed	Fixed
D-kit	Fixed	Adjustable
<b>RRP</b>	<b>£303.00</b>	<b>£305.00</b>

## Factory 2 Lever Height Adjustable

	<b>CH0505 + AC1014 // Factory 2 Height Fixed + Static Foot Ring</b>	<b>CH0505 + AC1042 // Factory 2 Height Adjustable + Adjustable Foot Ring</b>
Overall	D600 W600 H1170 - 1300	D600 W600 H1000 - 1250
Seat	D435 W465 H705 - 835	D435 W465 H565 - 820
Back	W415 H305	W415 H305
FR	Low	Low
Fabric	Polyurethane	Polyurethane
Mechanism	PCB	PCB
D-Kit:	Fixed	Adjustable
<b>RRP</b>	<b>£337.00</b>	<b>£339.00</b>



# Operator Chair Arms

Finishes:



Black

\*All sold as pairs

## Calypso & Concept Arms



Code	Description	RRP
AC1002	Fixed arms	£67.00



Code	Description	RRP
AC1040	1D Adjustable arms	£70.00



Code	Description	RRP
AC1082	Folding arms	£105.00

## Versi Arms



Code	Description	RRP
AC0001FA	Fixed arms	£39.00



Code	Description	RRP
AC0002AA	1D Adjustable arms	£55.00

# Accessories

## Technical



Code	Description	RRP
AC1042	Height adjustable D-Kit	£101.00



Code	Description	RRP
AC1014	Fixed D-Kit	£96.00



Code	Description	RRP
AC1024	Standard Chrome Base	£64.00

**Factory Chairs:** Your comfort and safety is our primary concern. We advise never to use the Factory or Concept range D-kits on any chair with a tilting seat, or to use anything other than the glides provided. Castors are not recommended with any draughtsman kit.

## Castors / Glides



\*Sold as sets of 5

Code	Description	RRP
AC1030	11mm onion glides	£19.00



\*Sold as singles

Code	Description	RRP
AC1050	Anti-static castors	£64.00



\*Sold as sets of 5

Code	Description	RRP
AC1047	Brake loaded castors	£20.00



\*Sold as singles

Code	Description	RRP
AC1048	Brake unloaded castors	£28.00



\*Sold as sets of 5

Code	Description	RRP
AC1051	Soft type castors	£10.00

# Soft Seating

// 01

Refresh your space with our fantastic soft seating collection. Available in a range of sizes and styles, create an inviting atmosphere, perfect for relaxing and recharging.





**Pocket**  
page 77



**Settle**  
page 77



**Pearl**  
page 79



**Jade**  
page 79



**Kona**  
page 81



**Curve**  
page 83



**Tub Lux**  
page 84



**Tub**  
page 84



**Iceberg**  
page 85



**Iceberg**  
page 85



**Glacier**  
pages 86-87



**Rubic**  
page 87



**Button**  
page 89



**Phonic High**  
page 90



**Phonic Low**  
page 91



# Pocket

Fabric finishes:



- Ergonomically designed seat and back with moulded foam for optimal comfort
- Sleek industrial wire frame with a black powder-coated finish and sturdy steel rod sled base
- Ideal for breakout areas, social spaces, and collaborative environments
- Plush, soft cushioned seat for added comfort and support

## OF0713 // Pocket

Overall	D670 W710 H720
Seat	D580 W500 H440
Back	W530 H300
FR	Med
Fabric	100% Man-made
RRP	£540.00

# Settle

Fabric finishes | PU Finish:

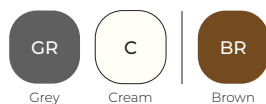

- Comfortable armchair featuring a plush seat and back supported by a metal-painted frame with wooden armrests
- Ideal for various environments, including breakout areas, waiting rooms, reception spaces, and hospitality settings
- Designed with sleek steel tube frames for durability
- Generously padded cushions for enhanced comfort
- Available in grey fabric and brown PU with dark varnished wood armrests, and cream fabric with natural wood armrests

## OF0714 // Settle

Overall	D725 W685 H820
Seat	D650 W510 H460
Back	W630 H550
FR	Med
Fabric	100% Man-made
RRP	£375.00





# Pearl Armchair

Fabric finishes:

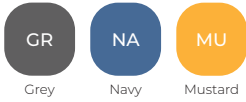

- Black industrial steel style frame
- Deep seat and back for contemporary but comfortable seating

## OF0705 // Pearl Armchair

Overall	D760 W660 H860
Seat	D500 W530 H425
Back	W490 H530
FR	Med
Fabric	100% Man-made
RRP	£439.00

# Jade Armchair

Fabric finishes:



**NEW  
GREEN  
FINISH  
FOR  
2025**



- Black industrial steel style frame
- Deep seat and back for contemporary but comfortable seating

## OF0704 // Jade Armchair

Overall	D790 W640 H825
Seat	D655 W600 H430
Back	W585 H490
FR	Med
Fabric	100% Man-made
RRP	£366.00



# Kona

Fabric seat finish:



Unlimited

Unlimited fabric available. Please contact our sales team for more information.



## Kona Chair

- Black industrial style wire frame
- Deep seat and back for contemporary and comfortable seating
- Available in an Italian polyester fabric
- Available with back support cushion

### CH0761CVTUN // Kona Chair

Overall	D710 W670 H760
Seat	D490 W670 H440
Back	W470 H440
FR	Med
Fabric	100% Man-made
RRP	£557.00



## Kona Chair with Tablet

- Black industrial style wire frame
- Available with back support cushion
- Available in an Italian polyester fabric
- Optional cushion available, please contact our sales team

### CH0763CVTUN // Kona Chair with Tablet

Overall	D710 W670 H760
Seat	D490 W670 H440
Back	W470 H440
FR	Med
Fabric	100% Man-made
Tablet	Fixed
RRP	£637.00



## Kona High Stool

- Black industrial style wire frame
- Perfect for use in bistros, cafés and break out areas
- Available in an Italian polyester fabric

### CH0760CVTUN // Kona High Stool

Overall	D560 W465 H975
Seat	D370 W435 H770
Back	W435 H225
FR	Med
Fabric	100% Man-made
RRP	£414.00





# Curve

Fabric finish:

**GR**

Grey

- Soft, plush seat and back crafted from high-density, fire-retardant foam
- Perfect for breakout areas, waiting rooms, and reception spaces
- Durable steel base and tubular frame with a sleek black powder-coated finish
- Designed for versatility, allowing easy reconfiguration to suit any space or occasion



## Curve Armchair

### OF0231 // Armchair

Overall	D720 W870 H750
Seat	D530 W720 H415
Back	W440 H365
FR	Med
Fabric	100% Man-made
RRP	£875.00

## Curve 2 Seater Sofa

### OF0232 // 2 Seater Sofa

Overall	D720 W1500 H750
Seat	D530 W1360 H415
Back	W1050 H365
FR	Med
Fabric	100% Man-made
RRP	£1,295.00



## Curve 3 Seater Sofa

### OF0233 // 3 Seater Sofa

Overall	D720 W2160 H750
Seat	D530 W1720 H415
Back	W1720 H365
FR	Med
Fabric	100% Man-made
RRP	£1,625.00

# Tub Lux

Leather-look finishes:



- Deep cushioned seat and back upholstered in PU



115 KG  
Weight Tolerance



230 KG  
Weight Tolerance

## Tub Lux Armchair

Codes	OF2201LML - Lime OF2201BML - Blue OF2201ORML - Orange OF2201RDML - Red OF2201SBML - Sky Blue OF2201BKML - Black
Overall	D700 W760 H740
Seat	D520 W510 H430
Back	W410 H325
FR	Med
Fabric	Leather-look
RRP	£558.00

## Tub Lux Sofa

Codes	OF2200LML - Lime OF2200BML - Blue OF2200ORML - Orange OF2200RDML - Red OF2200SBML - Sky Blue OF2200BKML - Black
Overall	D700 W1245 H740
Seat	D520 W1000 H430
Back	W900 H325
FR	Low
Fabric	Leather-look
RRP	£1,095.00

# Tub

Finish:



Black

- Plush cushioned back with stylish stitching detail



115 KG  
Weight Tolerance



230 KG  
Weight Tolerance

## Tub Armchair

OF0201 // Tub Armchair	
Overall	D610 W680 H750
Seat	D480 W445 H445
Back	W470 H330
FR	Med
Fabric	Leather-look
RRP	£466.00

## Tub Sofa

OF0200 // Tub Sofa	
Overall	D610 W1240 H750
Seat	D480 W1010 H445
Back	W590 H330
FR	Med
Fabric	Leather-look
RRP	£700.00

# Iceberg with wooden foot

Made to order finish:



Unlimited

- A modern, stylish soft seating collection, with wooden feet, and deep cushioned seat and arms



115 KG  
Weight Tolerance



230 KG  
Weight Tolerance



## Iceberg Armchair with wooden foot

OF0300WDB1UN // Iceberg wooden foot armchair

Overall	D760 W850 H810
Seat	D530 W540 H450
Back	W580 H360
FR	Low
Fabric	100% Man-made
RRP	£1,261.00

## Iceberg Sofa with wooden foot

OF0301WDB1UN // Iceberg wooden foot sofa

Overall	D760 W1340 H810
Seat	D530 W1090 H450
Back	W1090 H360
FR	Low
Fabric	100% Man-made
RRP	£1,500.00

# Iceberg with metal foot

Stocked finish | Made to order finish:



Black



Unlimited

- A modern leather-faced collection with metal feet, deep cushioned seat and arms



115 KG  
Weight Tolerance



230 KG  
Weight Tolerance



## Iceberg Armchair with metal foot

OF0300 // Iceberg black metal foot armchair

Overall	D740 W850 H820
Seat	D520 W540 H480
Back	W540 H340
FR	Low
Fabric	Leather-faced
RRP	£873.00

## Iceberg Sofa with metal foot

OF0301 // Iceberg black metal foot sofa

Overall	D740 W1380 H820
Seat	D520 W1080 H480
Back	W1080 H340
FR	Low
Fabric	Leather-faced
RRP	£1,159.00

# Glacier

Fabric finishes:



## Glacier

- Fully upholstered modular reception chair
- Deep seat and back with plastic feet

### OF0601 // Glacier

Overall	D700	W620	H790
Seat	D475	W620	H380
Back	W620	H390	
FR	Med		
Fabric	100% Man-made		
RRP	£344.00		



## Glacier Arm

- Single arm for the Glacier range of modular reception seating
- Fully upholstered and generously padded
- Can be used as left or right arm

### OF0602 // Glacier Arm

Overall	D650	W90	H610
FR	Med		
Fabric	100% Man-made		
RRP	£103.00		



# Rubic

Fabric finishes:



Royal Blue



Charcoal



Unlimited

Unlimited fabric available. Please contact our sales team for more information.



5 YR  
Component  
Guarantee



2 YR  
Upholstery  
Guarantee



115 KG  
Weight  
Tolerance



8  
Hours  
Usage



- A comfortable and durable waiting room chair
- Deep foam seat and back
- Black metal legs

## OF0307 // Rubic Chair

Overall	D670 W520 H800
Seat	D550 W530 H430
Back	W530 H390
FR	Med
Fabric	100% Man-made
RRP	£336.00



## Glacier Table

- Square low table with light beech top and upholstered sides
- Ideal for use with Glacier chairs
- Black feet for stability

## OF0603 // Glacier Table

Overall	D620 W620 H370
FR	Med
Fabric	100% Man-made
RRP	£234.00



# Button

Fabric finish:



Unlimited

- We can supply optional power modules which can be integrated into the product. Please see pages 282-283 for power options
- Coloured button upholstery detailing and black feet complete the look
- Priced in Camira Advantage fabric



## Button 3 Seater Sofa

### OF1703 // Button 3 Seater Sofa

Overall	D750 W2040 H770
Seat	D530 W1800 H430
Back	W1800 H340
FR	Subject to fabric selected
Fabric	100% Man-made
<b>RRP</b>	<b>£1,395.00</b>



## Button Armchair

### OF1701 // Button Armchair

Overall	D750 W840 H770
Seat	D530 W600 H430
Back	W600 H340
FR	Subject to fabric selected
Fabric	100% Man-made
<b>RRP</b>	<b>£965.00</b>



## Button 2 Seater Sofa

### OF1702 // Button 2 Seater Sofa

Overall	D750 W1440 H770
Seat	D530 W1200 H430
Back	W1200 H340
FR	Subject to fabric selected
Fabric	100% Man-made
<b>RRP</b>	<b>£1,185.00</b>

# Phonic High



Fabric finish:



- We can supply optional power modules which can be integrated into tables and infill panels. Please see pages 282-283 for power options
- Solid high arms and back to provide privacy and noise reduction whilst working
- Stylish black feet
- Priced in Camira Band 2 fabric



## Phonic High Armchair

OF3901 // Phonic High Armchair	
Overall	D750 W820 H1350
Seat	D550 W550 H450
Back	W550 H850
FR	Subject to fabric selected
Fabric	100% Man-made
RRP	£1,485.00

## Phonic High 2 Seater Sofa

OF3902 // Phonic High 2 Seater Sofa	
Overall	D750 W1350 H1350
Seat	D550 W1100 H450
Back	W1100 H850
FR	Subject to fabric selected
Fabric	100% Man-made
RRP	£1,685.00

## Phonic High 3 Seater Sofa

OF3903 // Phonic High 3 Seater Sofa	
Overall	D750 W1900 H1350
Seat	D550 W1650 H450
Back	W1650 H850
FR	Subject to fabric selected
Fabric	100% Man-made
RRP	£1,895.00

Made to order table finishes | Made to order leg finishes:



## High Infill Panel & Table

- Single leg table can only be used with the Phonic infill panel for the 3 seater sofa
- Supplied with all fittings needed
- Priced in Camira Band 2 fabric

**NOTE:** Overall dimensions shown in image: D750 W2100 H1900

OF3903FUI // High Infill Panel & Table	
Overall	W1000 H1275
FR	Subject to fabric selected
Fabric	100% Man-made
RRP	£699.00

OF0903TAB // Table	
Overall	D910 - 400 W1400 H711
FR	Subject to fabric selected
Fabric	100% Man-made
RRP	£265.00

\* Products are shown in Camira Yoredale/Boucle

# Phonic Low

Fabric finish:



Unlimited

- We can supply optional power modules which can be integrated into tables and infill panels. Please see pages 282-283 for power options
- Solid arms and back providing privacy and noise reduction whilst working
- Stylish black feet
- Priced in Camira Band 2 fabric



115 KG  
Weight Tolerance



230 KG  
Weight Tolerance



345 KG  
Weight Tolerance

## Phonic Low Armchair

### OF3900 // Phonic Low Armchair

Overall	D750 W820 H940
Seat	D550 W550 H450
Back	W550 H490
FR	Subject to fabric selected
Fabric	100% Man-made
RRP	£1,218.00

## Phonic Low 2 Seater Sofa

### OF3904 // Phonic Low 2 Seater Sofa

Overall	D750 W1300 H940
Seat	D550 W1100 H450
Back	W1000 H490
FR	Subject to fabric selected
Fabric	100% Man-made
RRP	£1,365.00

## Phonic Low 3 Seater Sofa

### OF3905 // Phonic Low 3 Seater Sofa

Overall	D750 W1900 H940
Seat	D550 W1650 H450
Back	W1650 H490
FR	Subject to fabric selected
Fabric	100% Man-made
RRP	£1,600.00

Made to order table finishes | Made to order leg finishes:



## Low Infill Panel & Table

- Single leg table can only be used with the Phonic infill panel for the 3 seater sofa
- Supplied with all fittings needed
- Priced in Camira Band 2 fabric

**NOTE:** Overall dimensions shown in image: D750 W2100 H940

### OF3906FU // Low Infill Panel & Table

Overall	W1000 H940
FR	Subject to fabric selected
Fabric	100% Man-made
RRP	£573.00



# Kuddle

In search of versatile, functional, and stylish soft seating that will enhance the appeal of your office space? Explore the Kuddle soft seating collection, a tailor-made solution for collaborative work, focused learning, and inviting social environments.

Meticulously designed and expertly crafted in the UK, the Kuddle Collection offers a diverse selection of sofas, dens, and booths in a range of sizes and styles, presenting modern, comfortable, and distinctive furniture that seamlessly adapts to the unique aesthetic of your office.

The Kuddle Collection goes beyond the ordinary, providing a fully customisable experience with a wide variety of fabrics and finishes to choose from. Kuddle also offers optional integrated power supplies to support laptops, phones, and screens, ensuring your workspace remains technologically efficient.

Transform your office with the Kuddle Collection. An embodiment of modernity, comfort, and uniqueness that effortlessly integrates into any professional environment. Elevate your workspace with style and practicality, creating an atmosphere that inspires collaboration and innovation.

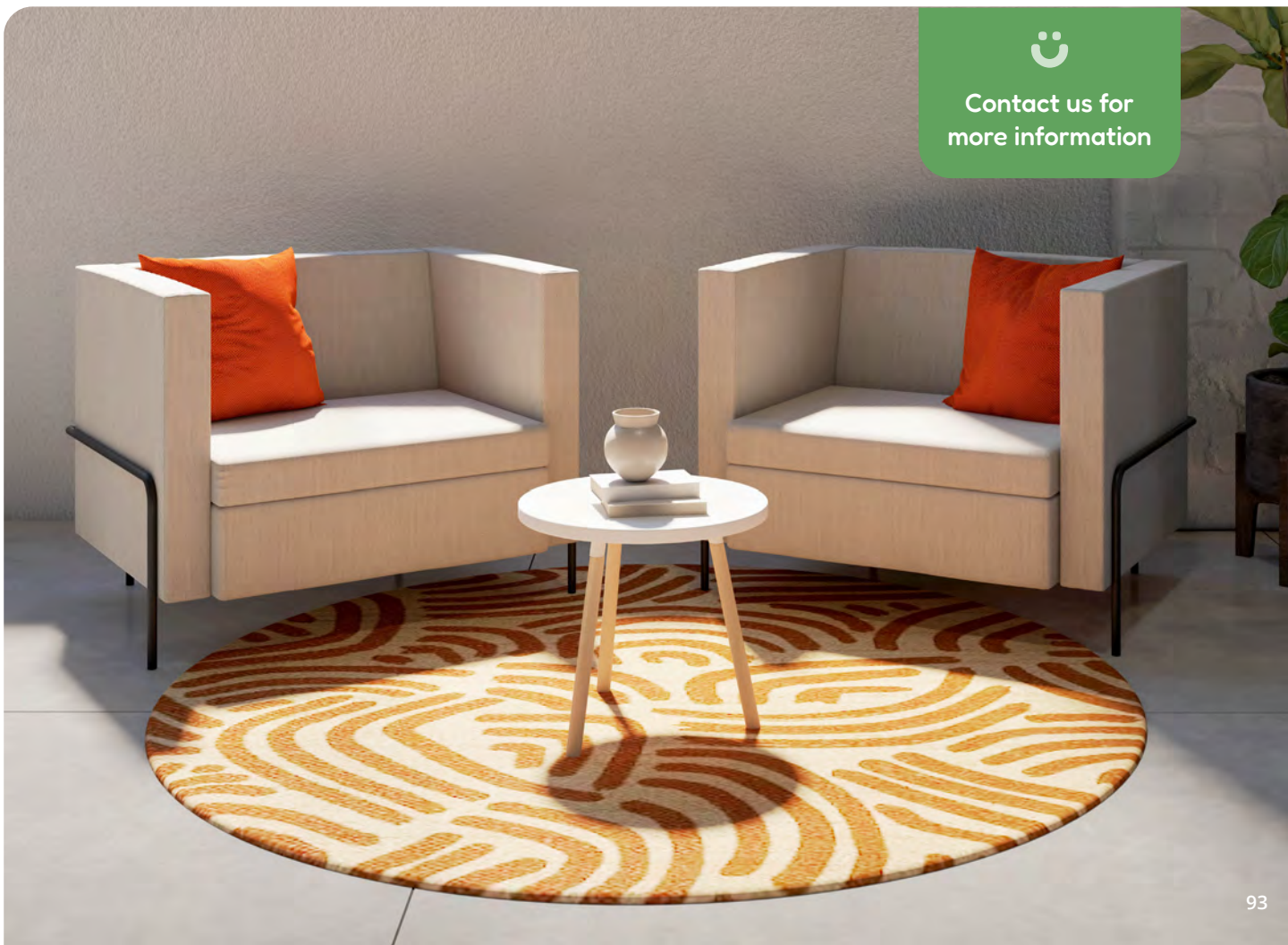

Contact us for  
more information

# Café & Dining Collection

// 02

Create your ideal oasis with our stunning café and dining collection. Whether you're into classic or contemporary, we have something to suit every style.



**Like this chair?**

Lizzie 4 Leg chairs (CH3518)  
in white and blue on page 105





**Breeze Family**

pages 96-99



**Tavern**

page 103



**Ledge**

page 103



**Lizzie Family**

pages 104-105



**Arc Family**

pages 106-109



**Picasso**

page 110-111



**Ellipse**

page 111



**Picnic**

page 112



**Contract**

page 112



**Stork**

page 113



**Astral High**

page 113



**Plateau**

pages 114-115



**Morph**

page 116



**Canteen**

page 117



**Economy Polypropylene**

page 117



# Breeze Family



Finishes:



Fair Green Brick Dust Charcoal



- A fresh outdoor range featuring tables, chairs, stools and bench options
- Crafted from durable and lightweight aluminium tubes
- Ideal for cafés, breakout areas and social spaces – suitable for both indoor and outdoor use
- Designed to withstand outdoor elements

## Breeze Chairs



### Breeze Side Chair

CH1652 // Breeze Side Chair

Overall	W505 D590 H840
Seat	W435 D400 H460
Back	W425 H400
FR	Low
Material	Aluminium
Storage	Stacks 10
RRP	£178.00



### Breeze Lounge Chair

CH1655 // Breeze Low Armchair

Overall	W685 D695 H750
Seat	W515 D496 H372
Back	W493 H390
FR	Low
Material	Aluminium
Storage	Stacks 10
RRP	£225.00



### Breeze Armchair

CH1651 // Breeze Armchair

Overall	W580 D590 H840
Seat	W435 D400 H460
Back	W425 H400
FR	Low
Material	Aluminium
Storage	Stacks 10
RRP	£205.00

Finishes:



# Breeze High Table & Bar Chair



## Breeze High Table

OF1662 // Breeze High Table

Overall W620 D620 H1050  
FR Low  
Material Aluminium  
RRP £350.00

## Breeze Bar Chair

CH1654 // Breeze Bar Chair

Overall W548 D586 H1038  
Seat W390 D375 H790  
Back W385 H276  
FR Low  
Material Aluminium  
RRP £160.00



E&OE. All items are subject to VAT, where applicable.

Finishes:



Fair Green Brick Dust Charcoal



# Breeze Benches



## Breeze 2 Seater Low Armchair Bench

CH1656 // Breeze Low Armchair Bench

Overall	W1170 D690 H750
Seat	W1000 D496 H403
Back	W980 H400
FR	Low
Material	Aluminium
RRP	£375.00

## Breeze 2 Seater Armchair Bench

CH1653 // Breeze Armchair Bench

Overall	W1302 D562 H824
Seat	W1158 D400 H460
Back	W1150 H434
FR	Low
Material	Aluminium
RRP	£350.00

# Breeze Tables



## Breeze Rectangular Slatted Table

OF1658 // Rectangular Slatted Table

Overall	W1806 D856 H756
FR	Low
Material	Aluminium
RRP	£765.00

## Breeze Square Slatted Table

OF1657 // Square Slatted Table

Overall	W820 D816 H756
FR	Low
Material	Aluminium
RRP	£365.00



# Shoal

Step into the world of Shoal, where benches aren't just benches – they're invitations to play, connect and thrive. A canvas for creativity.

From vibrant canteens to social oasis', Shoal sets the stage for spontaneous interactions and shared moments. It's where colleagues become closer, strangers become friends, and spaces become communities. Shoal isn't just about function—it's about infusing spaces with a sense of joy, sparking curiosity, and turning even the most mundane spaces into vibrant havens.

Join the Shoal community and let your space come alive with laughter, energy, and endless possibilities.



  
Contact us for  
more information





# Tavern

Leather-look finishes:



- Contemporary bistro design featuring a black steel frame and comfortable seat pad
- Perfect for a variety of café, dining and hospitality environments



## Tavern Side Chair

CH0678 // Tavern Side

Overall	W460 D540 H795
Seat	W395 D420 H455
Back	W425 H230
FR	Low
Material	Leather-look
RRP	£120.00



## Tavern High Chair

CH0679 // Tavern High

Overall	W460 D530 H1110
Seat	W395 D420 H775
Back	W425 H230
FR	Low
Material	Leather-look
RRP	£145.00

# Ledge

Top finish:



- Stylish bistro table and stool featuring an industrial rustic wood finish with a powder-coated steel tube frame
- Fixed foot ring on the stool for added comfort and support
- Unique tripod leg design for stability and aesthetic appeal
- Perfect for cafés, dining areas, casual breakout spaces, bars, and hospitality environments



## Ledge Table

CH6077 // Ledge Low Table

Overall	W800 D800 H730
FR	Low
Material	Wood/Steel
RRP	£250.00



## Ledge Stool

CH6079 // Ledge Stool

Overall	W420 D420 H760
FR	Low
Material	Wood/Steel
RRP	£85.00



## Ledge High Table

CH6078 // Ledge High Table

Overall	W700 D700 H1110
FR	Low
Material	Wood/Steel
RRP	£200.00



# Lizzie High Stool



**CH3519 // Lizzie High Stool**

Overall	W540 D570 H1130
Seat	W390 D470 H750
Back	W440 H450
FR	Low
Material	Polypropylene
RRP	£175.00



# Lizzie Family



Finishes:



- Stylish and practical
- Available in 8 contemporary colours
- Ideal for casual dining and meeting rooms

## Lizzie 4 Leg



**CH3518 // Lizzie 4 Leg**

Overall	W540 D570 H1130
Seat	W390 D470 H750
Back	W440 H450
FR	Low
Material	Polypropylene
RRP	£172.00

## Lizzie Skid



**CH3517 // Lizzie Skid**

Overall	W520 D570 H830
Seat	W390 D470 H450
Back	W440 H450
FR	Low
Material	Polypropylene
RRP	£160.00



Seat finishes:



## Arc Wooden Leg



- Designed for comfort and style with sleek wooden legs
- A robust, single shell, injection moulded chair
- Robust and long-lasting design
- Perfect for café, dining and casual breakout spaces
- Conforms to BSEN1729 Parts 1 & 2

	TA13_5 // Wooden Four Leg size 5	TA13_6 // Wooden Four Leg size 6
Overall	W425 D510 H820	W490 D540 H850
Seat	W425 D410 H430	W425 D410 H460
Back	W405 H425	W405 H425
FR	UL94 V-2	UL94 V-2
Material	Polypropylene	Polypropylene
Storage	Stacks 10	Stacks 10



# Arc Family



Seat finishes:



## Arc 4 Leg



- Designed for comfort and style with a classic 4 leg design
- A robust, single shell, injection moulded chair
- Robust and long-lasting design
- Perfect for café, dining and casual breakout spaces
- Conforms to BSEN1729 Parts 1 & 2

	TA1_5 // Arc Four Leg size 5	TA1_6 // Arc Four Leg size 6
Overall	W485 D520 H820	W490 D535 H855
Seat	W425 D410 H430	W425 D410 H460
Back	W405 H425	W405 H425
FR	UL94 V-2	UL94 V-2
Material	Polypropylene	Polypropylene
Storage	Stacks 10	Stacks 10

## Arc Skid



- Designed for comfort and style with a modern, skid-friendly frame
- A robust, single shell, injection moulded chair
- Robust and long-lasting design
- Perfect for café, dining and casual breakout spaces
- Conforms to BSEN1729 Parts 1 & 2

	TA3_5 // Arc Skid size 5	TA3_6 // Arc Skid size 6
Overall	W520 D500 H825	W530 D545 H855
Seat	W425 D410 H430	W425 D410 H460
Back	W405 H425	W405 H425
FR	UL94 V-2	UL94 V-2
Material	Polypropylene	Polypropylene
Storage	Stacks 10	Stacks 10

## Arc High Stool



- Designed for comfort and style with a sleek high stool frame featuring a foot base
- A robust, single shell, injection moulded chair
- Robust and long-lasting design
- Perfect for café, dining and casual breakout spaces
- Conforms to BSEN1729 Parts 1 & 2

	TA5_5 // Arc High Stool size 5	TA5_6 // Arc High Stool size 6
Overall	W510 D590 H1005	W530 D590 H1080
Seat	W425 D410 H610	W425 D410 H685
Back	W405 H425	W405 H425
FR	UL94 V-2	UL94 V-2
Material	Polypropylene	Polypropylene
Storage	Stacks 10	Stacks 10



**Like this chair?**

Arc High Density Stacker Chair shown with optional Seat Pad (TA17SPUN)

# Arc High Density

## Stacker Chair

Finishes:

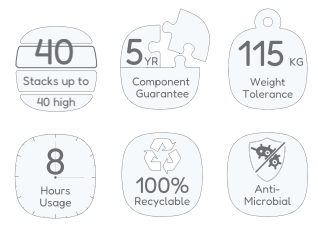

Stacks up to 40 chairs high

- The ideal chair, fitting easily into casual café and dining spaces
- Modern, contemporary and lightweight design, featuring skid-friendly frame and practical carry handle
- Conforms to BSEN1729 Parts 1 & 2

<b>TAI7 // Arc High Density Stacker Chair</b>		<b>TAI7LINK // Arc High Density Linking Clip   Black</b>
Overall	W510 D460 H 805	
Seat	W425 D400 H455	
Back	W420 H285	
FR	Low	
Material	Polypropylene	
Storage	Stacks 40	
		<b>TAI7SPUN // Arc High Density Stacker Seat Pad</b>

# Trolley

Finish:

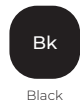

- Easy to control and manoeuvre with smooth-rolling castors
- Stacks up to 40 high
- Space-saving design for tight storage areas
- Securely holds stacked chairs firmly in place
- Perfect for event, conference, casual dining and education spaces

<b>TAI7TROLLEY // Arc High Density Trolley</b>	
Overall	W620 D890 H850
FR	Low
Material	Polypropylene



## Picasso Chair

Finishes:



Beech

Walnut



Stacks up to  
4 high



2 YR  
Component  
Guarantee



110 KG  
Weight  
Tolerance



5  
Hours  
Usage

- Welded chrome frame
- Stackable up to four high
- Plastic capped feet
- Suitable for cafés and canteens

### CH051BE // Picasso Chair Beech

Overall	D525 W485 H880
Seat	D380 W440 H460
Back	W430 H400
FR	Low
Material	Wood veneer
RRP	£124.00

### CH051WA // Picasso Chair Walnut

Overall	D525 W485 H880
Seat	D380 W440 H460
Back	W430 H400
FR	Low
Material	Wood veneer
RRP	£148.00



# Picasso Heavy Duty Chair



Finishes:



Beech



Walnut



White



- Welded chrome frame
- Stackable up to four high
- Plastic capped feet
- Suitable for cafés and canteens

## CH0672 // Picasso Heavy Duty

Overall	D525 W485 H880
Seat	D380 W440 H460
Back	W430 H400
FR	Low
Fabric	Wood veneer / painted in matt white
RRP	£169.00

# Ellipse Tables

Finishes:



Beech



Walnut



White



## Ellipse 4-Leg

- Plastic capped feet for stability
- Durable and easy-clean top
- Chrome legs

### CH0675 // Ellipse 4-leg

Overall	D800 W800 H740
FR	Low
Material	Wood veneer / painted in matt white
RRP	£124.00

## Ellipse Trumpet

- Heavy flared base for stability
- Durable and easy-clean top
- Chrome trumpet base

### CH0676 // Ellipse Trumpet

Overall	D800 W800 H740
FR	Low
Material	Wood veneer / painted in matt white
RRP	£148.00

# Picnic



Made to order top finishes:



Made to order frame finishes:



## Bench

Code	Dimensions	RRP
PCB1435 (fits 1600 low table)	W1400 D350 H410	£700.00
PCB1635 (fits 1800 low table)	W1600 D350 H410	£703.00
PCB1835 (fits 2000 low table)	W1800 D350 H410	£704.00

## Low Table

Code	Dimensions	RRP
PCTL1680	W1600 D800 H740	£865.00
PCTL1880	W1800 D800 H740	£867.00
PCTL2000	W2000 D800 H740	£915.00

## High Table

Code	Dimensions	RRP
PCTH1680	W1600 D800 H1100	£923.00
PCTH1880	W1800 D800 H1100	£941.00
PCTH2000	W2000 D800 H1100	£989.00

# Contract Tables



Stocked top finishes | Stocked frame finishes:



Made to order top finishes:



## Low Tables

Code	Dimensions	RRP
CH2683	W600 D600 H430	£342.00
CH2693	W800 D800 H430	£365.00

## Medium Tables

Code	Dimensions	RRP
CH2684	W600 D600 H725	£350.00
CH2694	W800 D800 H725	£374.00

## High Tables

Code	Dimensions	RRP
CH2685	W600 D600 H1105	£508.00
CH2695	W800 D800 H1105	£531.00

# Stork

Finishes:



5 YR  
Component Guarantee

115 KG  
Weight Tolerance

5  
Hours Usage



- Sculpted seat and back with wood veneer finish or lacquer
- Height adjustable seat
- Chrome trumpet base

### CH0672 // Picasso

Overall	D525 W485 H880
Seat	D380 W440 H460
Back	W430 H400
FR	Low
Fabric	Wood veneer / painted in matt white
RRP	£169.00

# Astral High Table

Finishes:

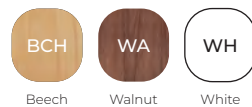

2 YR  
Component Guarantee

18 mm  
Top Thickness



- Heavy flared base for stability
- Durable and easy-clean top
- Chrome trumpet base

### CH0677 // Astral High Table

Overall	D600 W600 H1050
FR	Low
Fabric	Wood veneer / painted in matt white
RRP	£337.00





### High Table

Code	Dimensions	RRP
ZPLAP1410R	W1400 D1000 H1106	£1,813.00
ZPLAP1610R	W1600 D1000 H1106	£1,816.00
ZPLAP1810R	W1800 D1000 H1106	£1,818.00
ZPLAP2010R	W2000 D1000 H1106	£1,819.00
ZPLAP2210R	W2200 D1000 H1106	£1,822.00
ZPLAP2410R	W2400 D1000 H1106	£1,823.00



### High Stool

Code	Dimensions	RRP
SP-SPS-HSTL Plain	W382 D382 H830	£942.00
SP-SPS-HSTL-BTN Button	W382 D375 H830	£1,059.00



### Low Stool

Code	Dimensions	RRP
SPS-LSTL Plain	W375 D375 H500	£620.00
SPS-LSTL-BTN Button	W375 D375 H500	£620.00



### Low Bench

Code	Dimensions	RRP
SP-SPS-N Plain	W1180 D375 H500	£942.00
SP-N-BTN Button	W1180 D375 H500	£1,059.00

# Plateau



Made to order top finishes:



Frame finish | Fabric finish:

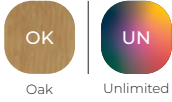

- Modern and practical design, with stylish wooden accents that enhances café and dining spaces
- Tables feature sleek, wooden legs and a range of 8 contemporary top finishes



## Round Table

Code	Dimensions	RRP
ZPLA1200D	W1200 D1200 H740	£1,397.00
ZPLA1400D	W1400 D1400 H740	£1,753.00



## Square Table

Code	Dimensions	RRP
ZPLA1414S	W1400 D1400 H740	£1,922.00
ZPLA1616S	W1600 D1600 H740	£1,936.00



## Rectangular Table

Code	Dimensions	RRP
ZPLA1680R	W1600 D800 H740	£1,359.00
ZPLA1890R	W1800 D900 H740	£1,368.00
ZPLA2010R	W2000 D1000 H740	£1,502.00
ZPLA2210R	W2200 D1000 H740	£1,507.00
ZPLA2412R	W2400 D1200 H740	£1,891.00



## Barrel Table

Code	Dimensions	RRP
ZPLA2010B	W2000 D1000 H740	£1,591.00
ZPLA2412B	W2400 D1200 H740	£1,936.00

# Morph Folding Chair



Finish:



White



- Durable off-white folding chair with moulded handle and plastic feet
- Sturdy dark grey metal legs and frame
- Wipe-clean surfaces and hinged folding mechanism

## OF0410WH // Morph Folding Chair

Overall	D530 W460 H880
Seat	D530 W390 H450
Back	W460 H290
FR	Low
Fabric	Polypropylene
Storage	Folding
RRP	£107.00

# Morph Rectangular Folding Table



Finish:



White



- Rectangular folding table with an off-white plastic top
- Sturdy dark grey metal legs and frame
- Wipe-clean top with rounded edges

	Dimensions	RRP
OF0403WH	W1220 D590 H725	£142.00
OF0402WH	W1520 D730 H725	£198.00
OF0401WH	W1820 D750 H725	£235.00W

# Canteen Chair



Finishes:



- Versatile stacking chair suitable for canteens, break out areas and both public and private sectors
- Wipe clean, polypropylene seat and back
- Robust, powder coated, black frame
- Conforms to BSEN1729 Parts 1 & 2

## CH0506 // Canteen Chair

Overall	D585 W660 H780
Seat	D390 W460 H435
Back	W460 H320
FR	Low
Fabric	Polypropylene
Storage	Stacks up to 4 high
RRP	£86.00

# Economy Polypropylene Chair



Finishes:



- Multi-purpose lightly textured plastic chair with tubular steel frame, suitable for a number of uses including schools and industrial environments
- Non-marking skid plastic feet prevent damage to hard floors

## ECOPOLY // Economy Polypropylene Chair

Overall	D520 W485 H750
Seat	D395 W430 H450
Back	W430 H530
FR	Low
Fabric	Polypropylene
Storage	Stacks up to 4 high
RRP	£68.00

# Synergy

// 02

Our flexible Synergy benching system is designed to fit any environment. Easily configure your product to your own needs, requirements and aesthetics to create the ultimate workspace.







**Back to Back Bench,  
Extension & D-End**  
pages 124-125



**Single Bench, Extension &  
Return**  
pages 128-129



**Meeting Tables**  
page 133



**Under Bench Options**  
page 134



**Storage**  
page 135



**Tone Acoustic Screens & Panels**  
page 137

# Bring your ideas to life

Configure your product to your own needs, requirements and aesthetics to create the ultimate workspace.

## Frame finish

Choose from 3 stocked frame finishes



## Cable channel

Neatly store and organise cables  
page 134

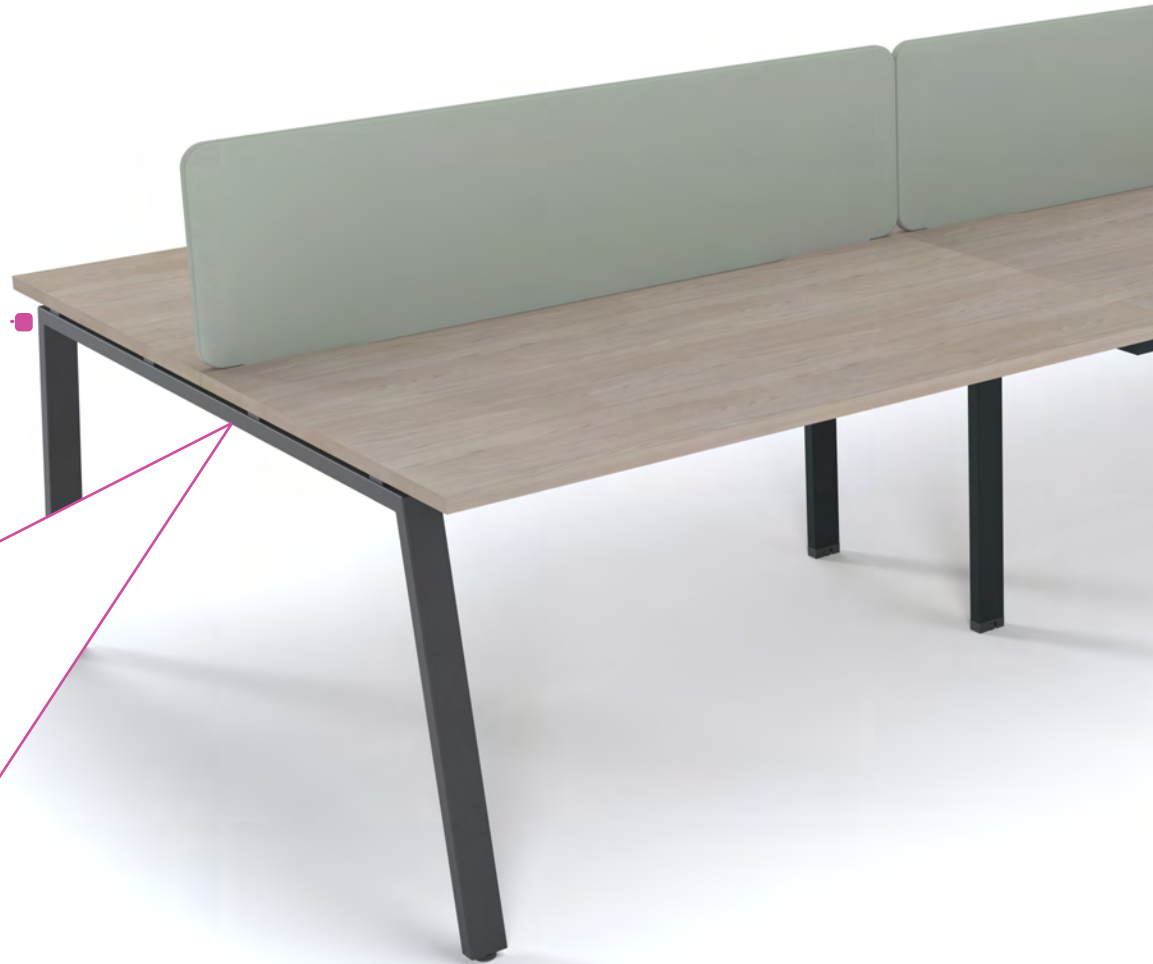

## Bench leg options

### A-frame

A modern, sleek appearance while ensuring stability with a strong, balanced triangular structure.

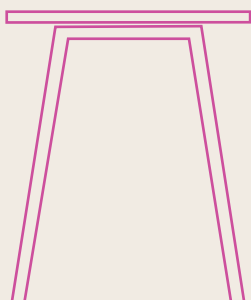

### Goalpost

A traditional, appearance that provides robust support, ensuring the table remains stable.

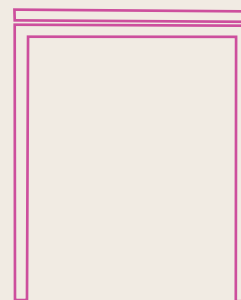

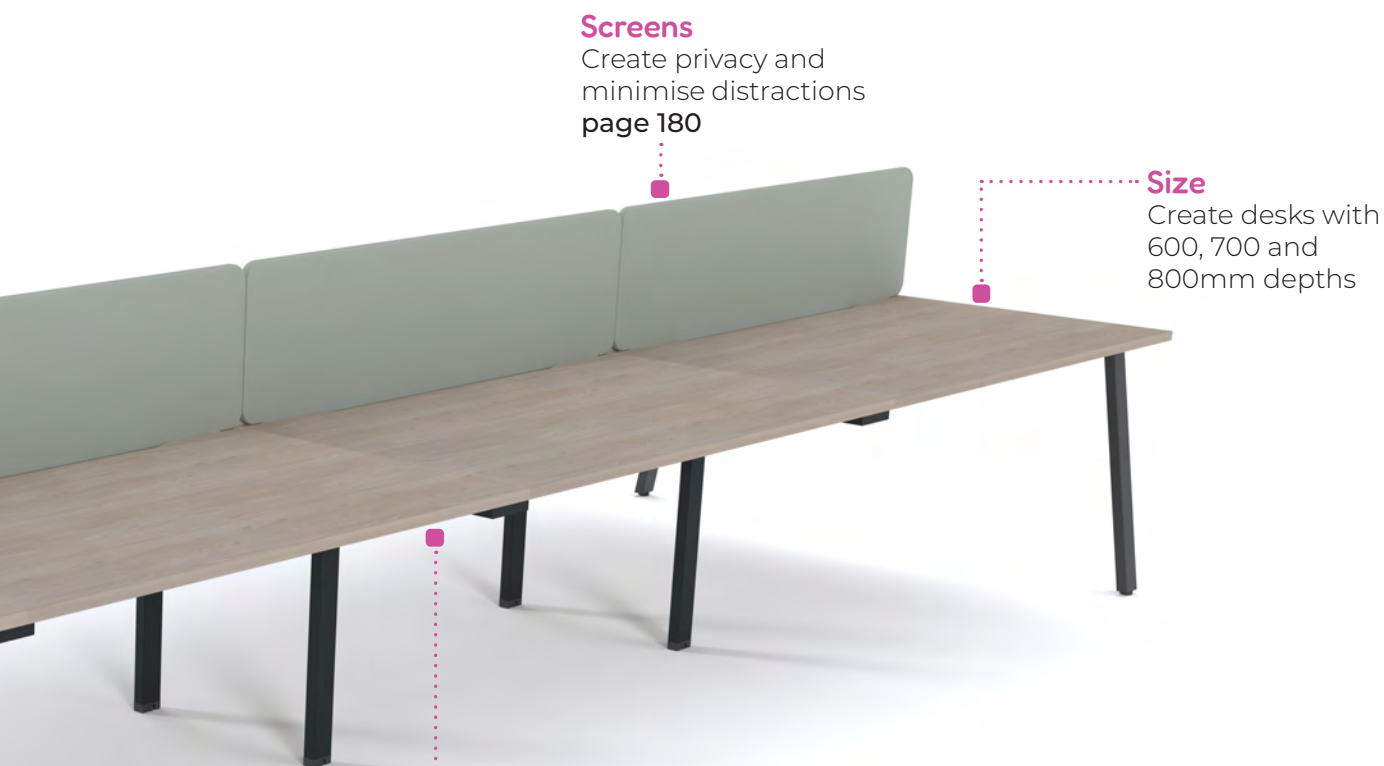

### Screens

Create privacy and minimise distractions  
page 180

### Size

Create desks with 600, 700 and 800mm depths

### Tops

Choose your top finish from stocked and MTO

#### Products featured:

- Synergy Back to Back bench. Nova Oak top with black A-frame leg finish, page 124
- Contempo rounded screens in MTO fabric, page 182
- Black Cable Channel, page 134

## Bench top options

### Cut Out

Provides better access to power outlets and cables, keeping the workspace tidy and organised.

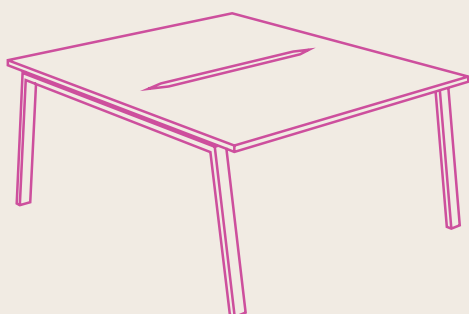

### Cable Port

Cables can be easily fed through the cable ports, under the desk, out of way while working.

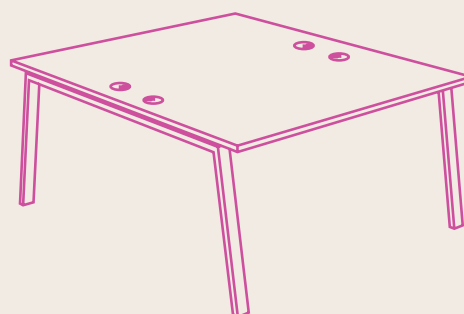

# Building Benches

Building benches is a great way to create functional and flexible workspaces.

Here's a guide to help you get started. With only a single tool required, assembly time is kept to a minimum.

**01.** Position the beams onto the end legs, ensuring they are oriented correctly and fully secured

**02.** Position the beams onto either the intermediate leg or end leg, depending on whether the configuration is a starter or extension

## 6 Person

Example of a 6 person back to back bench made from 1x2 person back to back and 2x2 person extension units



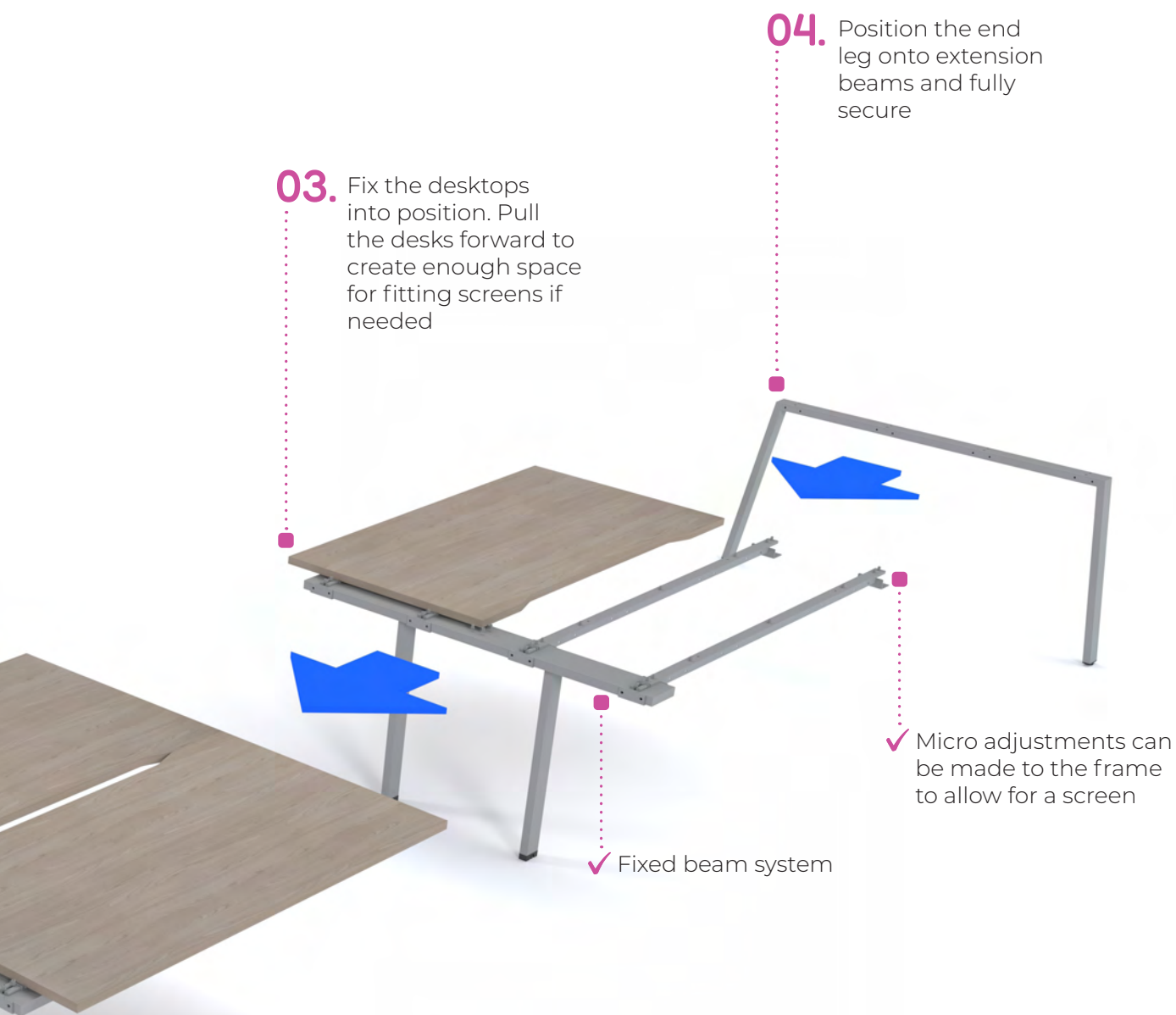

## Suit your team!

### 8 Person

Made from 1 x 2 person back to back and 3 x 2 person extension units



### 10 Person

Made from 1 x 2 person back to back and 4 x 2 person extension units



### 12 Person

Made from 1 x 2 person back to back and 5 x 2 person extension units



# Synergy Back to Back



Stocked top finishes | Made to order top finish



Stocked frame finishes | Made to order frame finish



Synergy Back to Back, space-saving desks are perfect for teams, offering flexible layouts.



## 2 Person Back to Back

- The ideal space-saving solution, allowing users to share a workspace efficiently
- Encourages teamwork and communication while maintaining personal workspace
- Quick and simple to set up or relocate, minimising disruption during office changes
- Compatible with a range of accessories, including cable channels, screens and more

**Desk Depths:** 600, 700, 800mm

**Desk Widths:** 1000, 1200, 1400, 1600mm

**Overall Depths:** 1200, 1400, 1600mm

Dimensions			Goalpost Leg - GPL		A Frame Leg - AFR		RRP (by finish)	
W	D	H	Cable Port	Cut Out	Cable Port	Cut Out	Aztec	Unlimited
1000	600	730	SYN1060CPGPL2P	SYN1060COGPL2P	SYN1060CPAFR2P	SYN1060COAFR2P	£420.00	£620.00
1000	700	730	SYN1070CPGPL2P	SYN1070COGPL2P	SYN1070CPAFR2P	SYN1070COAFR2P	£450.00	£650.00
1000	800	730	SYN1080CPGPL2P	SYN1080COGPL2P	SYN1080CPAFR2P	SYN1080COAFR2P	£480.00	£680.00
1200	600	730	SYN1260CPGPL2P	SYN1260COGPL2P	SYN1260CPAFR2P	SYN1260COAFR2P	£440.00	£640.00
1200	700	730	SYN1270CPGPL2P	SYN1270COGPL2P	SYN1270CPAFR2P	SYN1270COAFR2P	£470.00	£670.00
1200	800	730	SYN1280CPGPL2P	SYN1280COGPL2P	SYN1280CPAFR2P	SYN1280COAFR2P	£500.00	£705.00
1400	600	730	SYN1460CPGPL2P	SYN1460COGPL2P	SYN1460CPAFR2P	SYN1460COAFR2P	£460.00	£700.00
1400	700	730	SYN1470CPGPL2P	SYN1470COGPL2P	SYN1470CPAFR2P	SYN1470COAFR2P	£490.00	£730.00
1400	800	730	SYN1480CPGPL2P	SYN1480COGPL2P	SYN1480CPAFR2P	SYN1480COAFR2P	£520.00	£750.00
1600	600	730	SYN1660CPGPL2P	SYN1660COGPL2P	SYN1660CPAFR2P	SYN1660COAFR2P	£490.00	£735.00
1600	700	730	SYN1670CPGPL2P	SYN1670COGPL2P	SYN1670CPAFR2P	SYN1670COAFR2P	£520.00	£765.00
1600	800	730	SYN1680CPGPL2P	SYN1680COGPL2P	SYN1680CPAFR2P	SYN1680COAFR2P	£550.00	£795.00
1800	600	730	SYN1860CPGPL2P	SYN1860COGPL2P	SYN1860CPAFR2P	SYN1860COAFR2P	£540.00	£790.00
1800	700	730	SYN1870CPGPL2P	SYN1870COGPL2P	SYN1870CPAFR2P	SYN1870COAFR2P	£570.00	£820.00
1800	800	730	SYN1880CPGPL2P	SYN1880COGPL2P	SYN1880CPAFR2P	SYN1880COAFR2P	£600.00	£850.00



## 2 Person Extension

- Infinitely extend your existing benching to accommodate more team members
- Designed for easy installation, reconfiguration and relocation

**Desk Depths:** 600, 700, 800mm

**Desk Widths:** 1000, 1200, 1400, 1600mm

**Overall Depths:** 1200, 1400, 1600mm

\*Intermediate leg will always have a straight design as pictured

Dimensions			Cable Port	Extension Cut Out	RRP (by finish)	
W	D	H			Aztec	Unlimited
1000	600	730	SYN1060CP2PX	SYN1060CO2PX	£385.00	£530.00
1000	700	730	SYN1070CP2PX	SYN1070CO2PX	£415.00	£560.00
1000	800	730	SYN1080CP2PX	SYN1080CO2PX	£445.00	£590.00
1200	600	730	SYN1260CP2PX	SYN1260CO2PX	£410.00	£560.00
1200	700	730	SYN1270CP2PX	SYN1270CO2PX	£440.00	£590.00
1200	800	730	SYN1280CP2PX	SYN1280CO2PX	£470.00	£620.00
1400	600	730	SYN1460CP2PX	SYN1460CO2PX	£435.00	£580.00
1400	700	730	SYN1470CP2PX	SYN1470CO2PX	£465.00	£610.00
1400	800	730	SYN1480CP2PX	SYN1480CO2PX	£495.00	£640.00
1600	600	730	SYN1660CP2PX	SYN1660CO2PX	£465.00	£645.00
1600	700	730	SYN1670CP2PX	SYN1670CO2PX	£495.00	£675.00
1600	800	730	SYN1680CP2PX	SYN1680CO2PX	£525.00	£705.00
1800	600	730	SYN1860CP2PX	SYN1860CO2PX	£520.00	£695.00
1800	700	730	SYN1870CP2PX	SYN1870CO2PX	£550.00	£725.00
1800	800	730	SYN1880CP2PX	SYN1880CO2PX	£580.00	£755.00



## D-end

- The 'D' shape offers additional space for tasks and collaboration
- An easy add on to existing desks
- Creates a modern, professional look in your workspace

**Desk Depths:** 600, 800mm

**Desk Widths:** 1000, 1200, 1400, 1600mm

**Overall Depths:** 1200, 1400, 1600mm

Dimensions			Goalpost Leg - GPL	A Frame Leg - AFR	RRP (by finish)	
W	D	H			Aztec	Unlimited
1200	600	730	SYN1260GPLDE	SYN1260AFRDE	£180.00	£300.00
1200	800	730	SYN1280GPLDE	SYN1280AFRDE	£200.00	£350.00
1400	600	730	SYN1460GPLDE	SYN1460AFRDE	£200.00	£350.00
1400	800	730	SYN1480GPLDE	SYN1480AFRDE	£220.00	£400.00
1600	600	730	SYN1660GPLDE	SYN1660AFRDE	£220.00	£400.00
1600	800	730	SYN1680GPLDE	SYN1680AFRDE	£240.00	£450.00







# Synergy Single Bench



Stocked top finishes | Made to order top finish



Stocked frame finishes | Made to order frame finish



Single bench desking offers a smart, space-saving solution that gives everyone their own personal workspace while keeping the office open and connected.



## 1 Person

- Its sleek design fits effortlessly in smaller areas, while durable materials ensure long-lasting comfort
- Easy to assemble and available in a range of top and leg frame finishes, it's a versatile addition that elevates your workspace

**Desk Depths:** 600, 700, 800mm

**Desk Widths:** 1000, 1200, 1400, 1600, 1800mm

Dimensions			Goalpost Leg - GPL		A Frame Leg - AFR		RRP (by finish)	
W	D	H	Cable Port	Cut Out	Cable Port	Cut Out	Aztec	Unlimited
1000	600	730	SYN1060CPGPLIP	SYN1060COGPLIP	SYN1060CPAFR1P	SYN1060COAFR1P	£230.00	£330.00
1000	700	730	SYN1070CPGPLIP	SYN1070COGPLIP	SYN1070CPAFR1P	SYN1070COAFR1P	£260.00	£360.00
1000	800	730	SYN1080CPGPLIP	SYN1080COGPLIP	SYN1080CPAFR1P	SYN1080COAFR1P	£290.00	£375.00
1200	600	730	SYN1260CPGPLIP	SYN1260COGPLIP	SYN1260CPAFR1P	SYN1260COAFR1P	£240.00	£340.00
1200	700	730	SYN1270CPGPLIP	SYN1270COGPLIP	SYN1270CPAFR1P	SYN1270COAFR1P	£270.00	£370.00
1200	800	730	SYN1280CPGPLIP	SYN1280COGPLIP	SYN1280CPAFR1P	SYN1280COAFR1P	£300.00	£400.00
1400	600	730	SYN1460CPGPLIP	SYN1460COGPLIP	SYN1460CPAFR1P	SYN1460COAFR1P	£245.00	£365.00
1400	700	730	SYN1470CPGPLIP	SYN1470COGPLIP	SYN1470CPAFR1P	SYN1470COAFR1P	£275.00	£395.00
1400	800	730	SYN1480CPGPLIP	SYN1480COGPLIP	SYN1480CPAFR1P	SYN1480COAFR1P	£305.00	£425.00
1600	600	730	SYN1660CPGPLIP	SYN1660COGPLIP	SYN1660CPAFR1P	SYN1660COAFR1P	£270.00	£390.00
1600	700	730	SYN1670CPGPLIP	SYN1670COGPLIP	SYN1670CPAFR1P	SYN1670COAFR1P	£300.00	£420.00
1600	800	730	SYN1680CPGPLIP	SYN1680COGPLIP	SYN1680CPAFR1P	SYN1680COAFR1P	£330.00	£450.00
1800	600	730	SYN1860CPGPLIP	SYN1860COGPLIP	SYN1860CPAFR1P	SYN1860COAFR1P	£300.00	£415.00
1800	700	730	SYN1870CPGPLIP	SYN1870COGPLIP	SYN1870CPAFR1P	SYN1870COAFR1P	£330.00	£445.00
1800	800	730	SYN1880CPGPLIP	SYN1880COGPLIP	SYN1880CPAFR1P	SYN1880COAFR1P	£360.00	£475.00



## 1 Person Extension

- Expands your existing bench, creating additional workspace
- Designed for easy installation, reconfiguration and relocation

**Desk Depths:** 600, 700, 800mm

**Desk Widths:** 1000, 1200, 1400, 1600mm

**Overall Depths:** 1200, 1400, 1600, 1800mm

\*Intermediate leg will always have a straight design as pictured

Dimensions			Cable Port	Extension	Cut Out	RRP (by finish)	
W	D	H				Aztec	Unlimited
1000	600	730	SYN1060CP1PX	SYN1060CO1PX	£180.00	£280.00	
1000	700	730	SYN1070CP1PX	SYN1070CO1PX	£210.00	£310.00	
1000	800	730	SYN1080CP1PX	SYN1080CO1PX	£240.00	£340.00	
1200	600	730	SYN1260CP1PX	SYN1260CO1PX	£200.00	£300.00	
1200	700	730	SYN1270CP1PX	SYN1270CO1PX	£230.00	£330.00	
1200	800	730	SYN1280CP1PX	SYN1280CO1PX	£260.00	£360.00	
1400	600	730	SYN1460CP1PX	SYN1460CO1PX	£220.00	£320.00	
1400	700	730	SYN1470CP1PX	SYN1470CO1PX	£250.00	£350.00	
1400	800	730	SYN1480CP1PX	SYN1480CO1PX	£280.00	£380.00	
1600	600	730	SYN1660CP1PX	SYN1660CO1PX	£225.00	£345.00	
1600	700	730	SYN1670CP1PX	SYN1670CO1PX	£255.00	£365.00	
1600	800	730	SYN1680CP1PX	SYN1680CO1PX	£285.00	£400.00	
1800	600	730	SYN1860CP1PX	SYN1860CO1PX	£265.00	£360.00	
1800	700	730	SYN1870CP1PX	SYN1870CO1PX	£295.00	£390.00	
1800	800	730	SYN1880CP1PX	SYN1880CO1PX	£325.00	£420.00	



## Return

- Designed to complement your existing desk
- Adds extra surface area for multitasking, allowing more space for paperwork, monitors or equipment and improving organisation
- Can function as a dedicated space for collaboration, meetings or client interactions without leaving the primary desk
- Ideal for executives, managers or those needing extensive workplaces

**Desk Depths:** 600mm

**Desk Widths:** 800, 1000mm

Dimensions			Goalpost Leg - GPL	A Frame Leg - AFR	RRP (by finish)	
W	D	H			Aztec	Unlimited
800	600	730	SYN8060GPLRET	SYN8060AFRRET	£145.00	£275.00
1000	600	730	SYN1060GPLRET	SYN1060AFRRET	£155.00	£285.00







# Synergy Meeting Tables



Made to order top finishes:



Made to order frame finishes:



- Combining contemporary design and practical functionality
- Ideal for meetings, creative sessions, presentations, and team discussions
- All meeting tables are made to order
- Aztec finishes will be provided as two separate tops, wood grains will align closely, but not perfectly
- Egger (UN) and Kronospan (UN) finishes will be provided in one piece up to 2800 wide, wood grains will align closely, but not perfectly



## A-Frame Meeting Table

- The A-frame structure offers a modern, sleek appearance while ensuring stability with a strong, balanced frame design
- Easily adaptable for various meeting sizes and setups
- Can be customised with power module cut outs. Please add £25 (RRP) per cut out required

**Desk Depths:** 1600mm

**Desk Widths:** 2000, 2400, 2800, 3200, 3600mm



## Goalpost Meeting Table

- The goalpost frame provides robust support, ensuring the table remains stable even with heavy use
- Spacious table top accommodates multiple participants, technology, and paperwork comfortably
- Can be customised with power module cut outs. Please add £25 (RRP) per cut out required

**Desk Depths:** 1600mm

**Desk Widths:** 2000, 2400, 2800, 3200, 3600mm

Dimensions			Goalpost Leg - GPL	A Frame Leg - AFR	RRP (by finish)	
W	D	H			Aztec	Unlimited
2000	1600	730	SYN2016MTGPL	SYN2016MTAFR	£850.00	£1,200.00
2400	1600	730	SYN2416MTGPL	SYN2416MTAFR	£900.00	£1,300.00
2800	1600	730	SYN2816MTGPL	SYN2816MTAFR	£950.00	£1,400.00
3200	1600	730	SYN3216MTGPL	SYN3216MTAFR	£1,000.00	£1,500.00
3600	1600	730	SYN3616MTGPL	SYN3616MTAFR	£1,100.00	£1,900.00

# Under Bench Options



## Modesty Panels

Made to order finishes:



Modesty panels add privacy by hiding legs and cables, giving your desk a neat, professional look. Ideal for single desks in open offices or shared spaces. Available in wood and metal finishes.

Finish		Desk Size	RRP
Metal	Wooden		
SYN1200SMDP	SYN1200WMDP	W1200	£70.00
SYN1400SMDP	SYN1400WMDP	W1400	£75.00
SYN1600SMDP	SYN1600WMDP	W1600	£80.00



## Cable Spine

Stocked finish | Made to order finishes:



Neatly bundle and conceal cables, giving your desk an organised look. Ideal for preventing tangled wires and maintaining a clean, professional environment.



	Opaque (MTO)	Black (Stocked)	Silver (MTO)	RRP
Vertical Cable Manager	SYNVCMOP	SYNVCMBK	SYNVCMSV	£61.00



## Cable Channels

Made to order finishes:



Neatly store and organise cables, keeping them out of sight and reducing clutter. Designed to fit under desks or workstations.

Finish		Size	RRP
White	Black		
SYN1000CTWH	SYN1000CTBK	SYN1000CTSV W1000	£50.00
SYN1200CTWH	SYN1200CTBK	SYN1200CTSV W1200	£55.00
SYN1400CTWH	SYN1400CTBK	SYN1400CTSV W1400	£60.00
SYN1600CTWH	SYN1600CTBK	SYN1600CTSV W1600	£65.00
SYN1800CTWH	SYN1800CTBK	SYN1800CTSV W1800	£70.00



# Storage

**NEW**  
FOR 2025



## Personal Mobile Locker

Stocked finishes | Made to order finish:



Personal mobile lockers sit neatly under desks and provide a secure, sleek and space-efficient solution for individuals looking to safely store their belongings.

Code	Finish	Dimensions	RRP
TCSPMLWH	White	W352 D462 H615	£185.00
TCSPMLBK	Black	W352 D462 H615	£185.00
TCSPMLSV	Silver	W352 D462 H615	£185.00

## Wooden Lockers

Made to order finishes

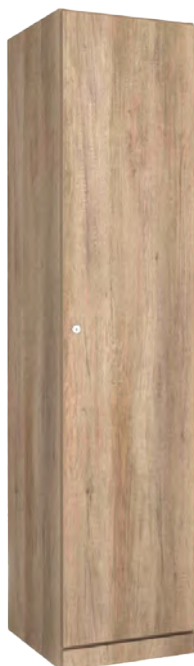

Our wooden lockers offer a secure, durable and simple storage solution with a classic natural look.

Available with a range of locks and handles, please contact our sales team for more details

Code	Doors	Dimensions	RRP
SL001UN	2 Door	W400 D500 H1075	£850.00
SL002UN	1 Door	W400 D500 H1800	£950.00
SL003UN	2 Door	W400 D500 H1800	£995.00
SL004UN	3 Door	W400 D500 H1800	£1,100.00
SL005UN	4 Door	W400 D500 H1800	£1,200.00



# Tone Acoustic Screens & Panels



Made to order finishes:



Unlimited



Tone Acoustic desk mounted screens and panels absorb sound, reduce echoes, and improve acoustics, offering a sleek, functional solution for noise control that creates a quieter, more focused workspace.



## Desk Mounted Screens

49mm thick desk mounted frameless (non-linking) sound absorbing screen

Code	Dimensions	RRP
TONE14UN	W800 H500	£445.00
TONE15UN	W1000 H500	£500.00
TONE16UN	W1200 H500	£530.00
TONE17UN	W1400 H500	£555.00
TONE18UN	W1600 H500	£615.00
TONE19UN	W1800 H500	£640.00
TONE20UN	W800 H600	£465.00
TONE21UN	W1000 H600	£520.00
TONE22UN	W1200 H600	£550.00
TONE23UN	W1400 H600	£575.00
TONE24UN	W1600 H600	£635.00
TONE25UN	W1800 H600	£660.00

## Wall Tiles

### Hexagonal Wall Tile

	Code	Dimensions	RRP
Small	TONE1UN	W500 H433	£235.00
Medium	TONE2UN	W700 H606	£265.00
Large	TONE3UN	W900 H779	£295.00

### Square Wall Tile

Small	TONE4UN	W600 H600	£250.00
Medium	TONE5UN	W800 H800	£285.00
Large	TONE6UN	W1200 H1200	£395.00

### Rectangular Wall Tile

Small	TONE8UN	W800 H1600	£410.00
Large	TONE7UN	W1200 H1600	£475.00



## Ceiling Hung Tiles

### Circular Ceiling Hung Tile

	Code	Dimensions	RRP
Small	TONE10UN	W800 H1600	£650.00
Large	TONE9UN	W1200 H1600	£715.00

### Circular Ceiling Hung Tile

Small	TONE12UN	W800 H800	£525.00
Large	TONE11UN	W1200 H1200	£630.00

### Circular Ceiling Hung Tile

Large	TONE13UN	W1200 H1200	£640.00
-------	----------	-------------	---------

# Aztec Collection

// 02

Revitalise your space with the Aztec collection. This range of wooden furniture comes in seven stunning colour finishes, letting you mix and match to create a workspace that's as stylish as it is functional.





**Goalpost Leg**  
page 141



**Height Adjustable  
Desks**  
pages 142-143



**Twin Upright Leg**  
pages 144-145



**Single Upright Leg**  
pages 146-147



**Panel Leg**  
pages 148-149



**Panel Plus**  
page 151



**Wooden Pedestals**  
page 152



**Wooden Filing**  
page 153



**Talos Steel Pedestals**  
page 153



**Pose**  
page 155



**Wooden Bookcases**  
page 156



**Wooden Cupboards**  
page 157



**Panel Plus Cupboards**  
page 158



**Wooden Tambours**  
page 159



**Tilting Tables**  
page 160



**Union Folding  
Tables**  
page 161



**Multi-purpose  
Tables**  
page 163

#### Care & Maintenance:

Due to its resistant, hygienic and dense surface, these laminates do not require any special form of care. The surface is generally easy to clean. Do not use sanitary cleaners or detergents with abrasive components, as such cleaners may lead to changes in the gloss level and/or scratching of the material.

#### Frame Finishes



White  
RAL9010



Silver  
RAL9006



Graphite  
RAL7011



Black  
RAL9005



# Goalpost Leg

Stocked top finishes | Frame finishes:



Made to order top finishes:

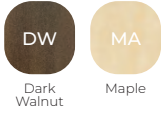

- Ultra modern goalpost leg with modesty panel
- Dark walnut and maple tops are made to order
- If a bespoke screen bracket is required, contact our Sales Team for more details



## 600 Deep Rectangular Desk

Code	Dimensions	RRP
GP1060REC	W1000 D600 H730	£282.00
GP1260REC	W1200 D600 H730	£350.00
GP1460REC	W1400 D600 H730	£378.00
GP1660REC	W1600 D600 H730	£405.00
GP1860REC	W1800 D600 H730	£436.00



## 800 Deep Rectangular Desk

Code	Dimensions	RRP
GP1280REC	W1200 D800 H730	£350.00
GP1480REC	W1400 D800 H730	£378.00
GP1680REC	W1600 D800 H730	£405.00
GP1880REC	W1800 D800 H730	£436.00



## Rectangular Desk with Return

Code	Dimensions	RRP
GP1680LHRET	L/H W1600 D800 H730 D <sup>2</sup> 1800	£569.00
GP1680RHRET	R/H W1600 D800 H730 D <sup>2</sup> 1800	£569.00
GP1880LHRET	L/H W1800 D800 H730 D <sup>2</sup> 1800	£596.00
GP1880RHRET	R/H W1800 D800 H730 D <sup>2</sup> 1800	£596.00

# Back to Back Height Adjustable



Stocked top finishes | Frame finishes:



Made to order top finishes:



**NEW**  
CONTROLLER  
FEATURES  
FOR  
**2025**



- Allows two users to work independently on the same workspace
- Preset your two optimum working heights using the built-in memory and digital display
- Twin motor
- Anti-collision
- Adjustable feet for levelling
- Featuring an adjustment range of 645-1305mm in height
- Touch screen
- USB-A and USB-C integrated into the side of the controller

Code	Dimensions	RRP
ECBB1280CP	W1200 D800 H645 - 1305	£2,031.00
ECBB1480CP	W1400 D800 H645 - 1305	£2,133.00
ECBB1680CP	W1600 D800 H645 - 1305	£2,235.00
ECBB1880CP	W1800 D800 H645 - 1305	£2,337.00

# Dual Motor Height Adjustable



Stocked top finishes | Frame finishes:



Made to order top finishes:



**NEW**  
CONTROLLER  
FEATURES  
FOR  
**2025**



- Preset your two optimum working heights using the built-in memory and digital display
- Twin motor
- Anti-collision
- Adjustable feet for levelling
- Featuring an adjustment range of 645-1305mm in height
- Touch screen
- USB-A and USB-C integrated into the side of the controller

Code	Dimensions	RRP
ECSS1280CP	W1200 D800 H645 - 1305	£816.00
ECSS1480CP	W1400 D800 H645 - 1305	£846.00
ECSS1680CP	W1600 D800 H645 - 1305	£875.00
ECSS1880CP	W1800 D800 H645 - 1305	£905.00



# Single Motor Height Adjustable



Stocked top finishes | Frame finishes:



Made to order top finishes:



- Allows users to easily switch between sitting and standing positions
- Promotes and encourages wellbeing
- Adapt the desk to users' preferences and ergonomic needs

Code	Dimensions	RRP
ECSM1280CP	W1200 D800 H645 - 1220	£571.00
ECSM1480CP	W1400 D800 H645 - 1220	£582.00





**Like this chair?**

Shift Chair (CH0756) in grey can be found on page 11



**Twin Upright Bundle**

Bundle includes an 800 Deep Twin Upright Rectangular Desk with either a 2 drawer or 3 drawer mobile pedestal

Code	Dimensions	RRP
TWU1280BUN2	2 Drawer W1200 D800 H730	£562.00
TWU1480BUN2	2 Drawer W1400 D800 H730	£600.00
TWU1680BUN2	2 Drawer W1600 D800 H730	£607.00
TWU1280BUN3	3 Drawer W1200 D800 H730	£562.00
TWU1480BUN3	3 Drawer W1400 D800 H730	£600.00
TWU1680BUN3	3 Drawer W1600 D800 H730	£607.00



**Twin Upright Radial Bundle**

Bundle includes a Double Upright 1600 or 1800 Radial Desk (left or right hand) and 600 deep desk high pedestal

Code	Dimensions	RRP
TWU1612BUN(*)	L/H & R/H W1600 D1200 H730 D <sup>2</sup> 800	£759.00
TWU1812BUN(*)	L/H & R/H W1800 D1200 H730 D <sup>2</sup> 800	£835.00

\* Please specify L or R in code, e.g. TWU1612BUNL for left hand desk

E&OE. All items are subject to VAT, where applicable.

# Twin Upright Leg



Stocked top finishes | Frame finishes:



Made to order top finish:

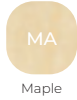

- A cost-effective workstation range with white, black or silver cantilever legs and a range of wooden desktop finishes
- Grey cable ports supplied as standard for all top finishes apart from black which has black cable ports
- Adjustable feet for levelling on uneven floors
- Modesty panels included

**FOR DESK SCREENS**  
page 181

**FOR MATCHING STORAGE**  
pages 152-159



## 600 Deep Rectangular Desk

Code	Dimensions	RRP
TWU8060REC	W800 D600 H730	£280.00
TWU1260REC	W1200 D600 H730	£330.00
TWU1460REC	W1400 D600 H730	£367.00
TWU1660REC	W1600 D600 H730	£385.00
TWU1860REC	W1800 D600 H730	£418.00

## 800 Deep Rectangular Desk

Code	Dimensions	RRP
TWU8080REC	W800 D800 H730	£280.00
TWU1280REC	W1200 D800 H730	£330.00
TWU1480REC	W1400 D800 H730	£367.00
TWU1680REC	W1600 D800 H730	£385.00
TWU1880REC	W1800 D800 H730	£418.00



## Radial Desk

Code	Dimensions	RRP
TWU1612(*)RAD	L/H & R/H W1600 D1200 H730 D²800	£467.00
TWU1812(*)RAD	L/H & R/H W1800 D1200 H730 D²800	£544.00



## Fixed Pedestal

Code	Dimensions	RRP
TESHP2/655	2 Drawer W404 D655 H500	£239.00
TESHP3/655	3 Drawer W404 D655 H500	£239.00

\* Please specify LH or RH in code, eg TWU1612LHRAD for left hand desk

Note // Fixed pedestals only fit the 800 deep desks



### Single Upright Bundle

Bundle includes an 800 Deep Single Upright Rectangular Desk with either a 2 drawer or 3 drawer mobile pedestal

Code	Dimensions	RRP
SU1280BUN2	2 Drawer W1200 D800 H730	£562.00
SU1480BUN2	2 Drawer W1400 D800 H730	£600.00
SU1680BUN2	2 Drawer W1600 D800 H730	£607.00
SU1280BUN3	3 Drawer W1200 D800 H730	£562.00
SU1480BUN3	3 Drawer W1400 D800 H730	£600.00
SU1680BUN3	3 Drawer W1600 D800 H730	£607.00



### Single Upright Radial Bundle

Bundle includes a Single Upright 1600 or 1800 Radial Desk (left or right hand) and 600 deep desk high pedestal

Code	Dimensions	RRP
SU1612BUN(*)	L/H & R/H W1600 D1200 H730 D²800	£759.00
SU1812BUN(*)	L/H & R/H W1800 D1200 H730 D²800	£835.00

\* Please specify L or R in code, e.g. SU1612BUNL for left hand desk

E&OE. All items are subject to VAT, where applicable.

# Single Upright Leg



Stocked top finishes | Frame finishes:



Made to order top finish:

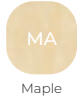

- Modern cantilever leg desk available with white, black or silver legs
- Grey cable ports supplied as standard for all top finishes apart from black which has black cable ports
- Adjustable feet for levelling on uneven floors
- Modesty panels included

**FOR DESK SCREENS**  
page 181

**FOR MATCHING STORAGE**  
pages 152-159



## 600 Deep Rectangular Desk

Code	Dimensions	RRP
SU8060REC	W800 D600 H730	£280.00
SU1260REC	W1200 D600 H730	£330.00
SU1460REC	W1400 D600 H730	£367.00
SU1660REC	W1600 D600 H730	£385.00
SU1860REC	W1800 D600 H730	£418.00

## 800 Deep Rectangular Desk

Code	Dimensions	RRP
SU8080REC	W800 D800 H730	£280.00
SU1280REC	W1200 D800 H730	£330.00
SU1480REC	W1400 D800 H730	£367.00
SU1680REC	W1600 D800 H730	£385.00
SU1880REC	W1800 D800 H730	£418.00



## Radial Desk

Code	Dimensions	RRP
SU1612(*)RAD	L/H & R/H W1600 D1200 H730 D²800	£467.00
SU1812(*)RAD	L/H & R/H W1800 D1200 H730 D²800	£544.00

## Fixed Pedestal

Code	Dimensions	RRP
TESHP2	2 Drawer W450 D540 H540	£230.00
TESHP3	3 Drawer W450 D540 H540	£230.00

\* Please specify LH or RH in code, eg SU1612LHRAD for left hand desk

Note // Fixed pedestals only fit the 800 deep desks



**Like this chair?**  
 Zip Chair (CH0757) in black  
 can be found on page 11



### Panel Leg Bundle

Bundle includes an 800 Deep Rectangular Desk with either a 2 drawer or 3 drawer mobile pedestal

Code	Dimensions	RRP
PAN1280BUN2	2 Drawer W1200 D800 H730	£562.00
PAN1480BUN2	2 Drawer W1400 D800 H730	£600.00
PAN1680BUN2	2 Drawer W1600 D800 H730	£607.00
PAN1880BUN2	2 Drawer W1800 D800 H730	£651.00
PAN1280BUN3	3 Drawer W1200 D800 H730	£562.00
PAN1480BUN3	3 Drawer W1400 D800 H730	£600.00
PAN1680BUN3	3 Drawer W1600 D800 H730	£607.00
PAN1880BUN3	3 Drawer W1800 D800 H730	£6251.00



### Single Upright Radial Bundle

Bundle includes a 1600 or 1800 Radial Desk (left or right hand) and 600 deep desk high pedestal

Code	Dimensions	RRP
PAN1612BUN(*)	L/H & R/H W1600 D1200 H730 D²800	£562.00
PAN1812BUN(*)	L/H & R/H W1800 D1200 H730 D²800	£600.00

\* Please specify L or R in code, e.g. PAN1612BUNL for left hand desk

E&OE. All items are subject to VAT, where applicable.

# Panel Leg



Stocked top finishes:

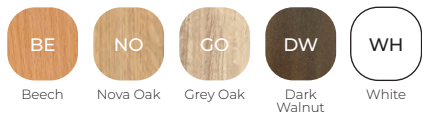

Made to order top finish:

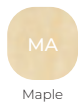

- Contemporary panel desk with integrated grey cable ports
- Metal to metal fixings for added strength
- Adjustable feet for levelling on uneven floors
- Maple finish is made to order - contact our Sales Team for lead time

**FOR DESK SCREENS**  
page 181

**FOR MATCHING STORAGE**  
pages 152-159



## 600 Deep Rectangular Desk

Code	Dimensions	RRP
PAN8060REC	W800 D600 H730	£280.00
PAN1260REC	W1200 D600 H730	£330.00
PAN1460REC	W1400 D600 H730	£367.00
PAN1660REC	W1600 D600 H730	£385.00
PAN1860REC	W1800 D600 H730	£418.00

## 800 Deep Rectangular Desk

Code	Dimensions	RRP
PAN8080REC	W800 D800 H730	£280.00
PAN1280REC	W1200 D800 H730	£330.00
PAN1480REC	W1400 D800 H730	£367.00
PAN1680REC	W1600 D800 H730	£385.00
PAN1880REC	W1800 D800 H730	£418.00



## Radial Desk

Code	Dimensions	RRP
PAN1612(*)RAD	L/H & R/H W1600 D1200 H730 D²800	£467.00
PAN1812(*)RAD	L/H & R/H W1800 D1200 H730 D²800	£544.00



## Fixed Pedestal

Code	Dimensions	RRP
TESHP2/655	2 Drawer W404 D655 H500	£239.00
TESHP3/655	3 Drawer W404 D655 H500	£239.00

\* Please specify LH or RH in code, eg PAN1612LHRAD for left hand desk

Note // Fixed pedestals only fit the 800 deep desks



**Like this chair?**  
Shift Chair (CH0756)  
can be found on page 11



# Panel Plus



Stocked top finishes:



Made to order top finish:

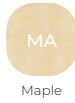

- All desks come with white legs and modesty panels
- Contemporary panel desk with integrated grey cable ports
- Metal to metal fixings for added strength
- Adjustable feet for levelling on uneven floors
- Maple tops are made to order - contact our sales team for lead time

**FOR DESK SCREENS**  
page 181

**FOR MATCHING STORAGE**  
pages 152-159



## 600 Deep Rectangular Desk

Code	Dimensions	RRP
PAN8060REC	W800 D600 H730	£280.00
PAN1260REC	W1200 D600 H730	£330.00
PAN1460REC	W1400 D600 H730	£367.00
PAN1660REC	W1600 D600 H730	£385.00
PAN1860REC	W1800 D600 H730	£418.00



## 800 Deep Rectangular Desk

Code	Dimensions	RRP
PAN8080REC	W800 D800 H730	£280.00
PAN1280REC	W1200 D800 H730	£330.00
PAN1480REC	W1400 D800 H730	£367.00
PAN1680REC	W1600 D800 H730	£385.00
PAN1880REC	W1800 D800 H730	£418.00



## Radial Desk

Code	Dimensions	RRP
PAN1612(*)RAD	L/H & R/H W1600 D1200 H730 D²800	£467.00
PAN1812(*)RAD	L/H & R/H W1800 D1200 H730 D²800	£544.00

\* Please specify LH or RH in code, e.g PP1612LHRAD for left hand desk



## Fixed Pedestal

Code	Dimensions	RRP
TESHP2/655	2 Drawer W404 D655 H500	£239.00
TESHP3/655	3 Drawer W404 D655 H500	£239.00

**Note //** Fixed pedestals only fit the 800 deep desks

# Wooden Pedestals



Stocked finishes | Made to order finishes:

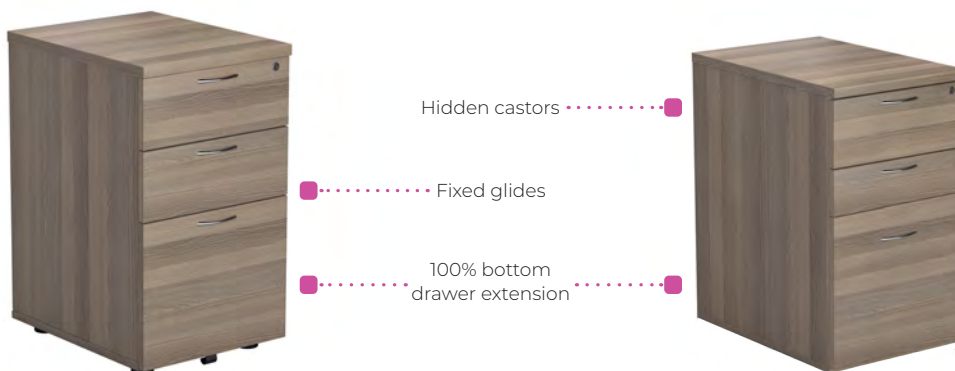
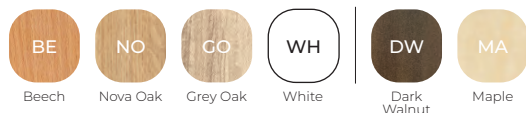

## Under Desk Static Pedestal

Code	Dimensions	RRP
TESUDP3	W404 D500 H690	£319.00

## 3 Drawer High Mobile Pedestal

Code	Dimensions	RRP
TESUHMP3	W404 D500 H636	£308.00

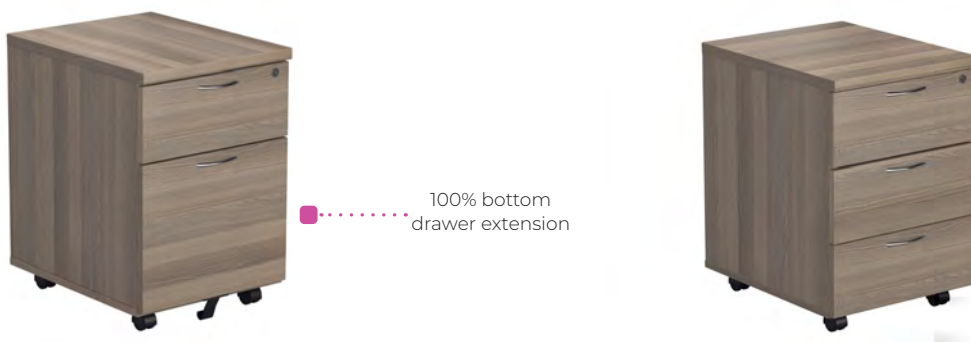

## 2 Drawer Mobile Pedestal

Code	Dimensions	RRP
TESMP2	W404 D500 H595	£239.00

Note: Stocked in Dark Walnut

## 3 Drawer Mobile Pedestal

Code	Dimensions	RRP
TESMP3	W404 D500 H595	£239.00

Note: Stocked in Dark Walnut

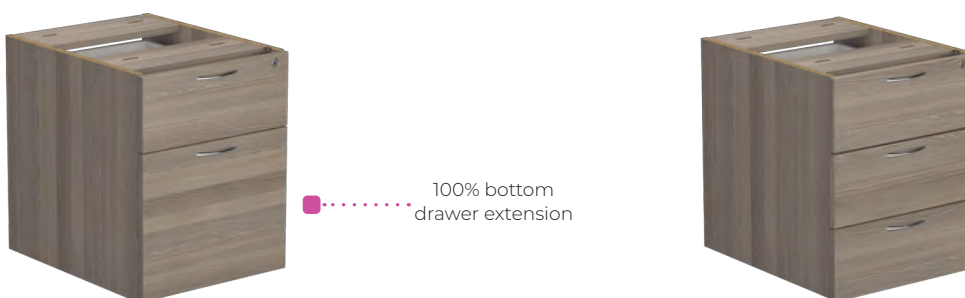

## 2 Drawer Fixed Pedestal

Code	Dimensions	RRP
TESHP2	Only fits SU desks W404 D500 H495	£230.00
TESHP2/665	Only fits PP, PAN & TWU desks W404 D655 H495	£239.00

## 3 Drawer Fixed Pedestal

Code	Dimensions	RRP
TESHP3	Only fits SU desks W404 D500 H495	£230.00
TESHP3/665	Only fits PP, PAN & TWU desks W404 D655 H495	£239.00

# Wooden Filing

Stocked finishes | Made to order finishes:

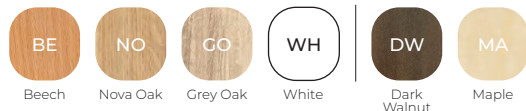

## Desk High Pedestal

Code	Dimensions	RRP
TESDHP3*	W404 D600 H730	£294.00
TESDHP3/800	W404 D800 H730	£373.00

\* Note: Stocked in Dark Walnut



## Heavy Duty Side Filer

Code	Dimensions	RRP
TKDH800SF	W800 D600 H730	£551.00



## 2 & 3 Drawer Filing Cabinets

Code	Dimensions	RRP
TES2FC	W464 D600 H710	£379.00
TES3FC	W464 D600 H1055	£449.00



## 4 Drawer Filing Cabinet

Code	Dimensions	RRP
TES4FC	W400 D800 H1390	£530.00

# Talos Steel Pedestals

Stocked finishes:

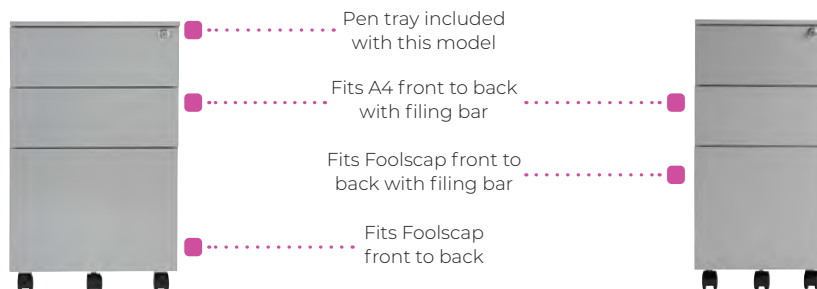

## Mobile Pedestal

Code	Dimensions	RRP
TKUSMP3	W380 D470 H615	£357.00

## Slimline Mobile Pedestal

Code	Dimensions	RRP
TKUSSMP3	W300 D470 H615	£335.00



# Pose

Made to order finishes | Frame finish:

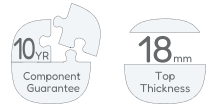
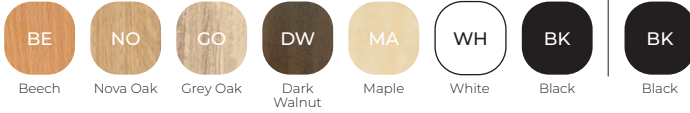

- Modular grid-based shelving and storage system for versatile organisation
- Transforms open-plan offices into multifunctional spaces
- Easily configurable and ideal for creating work zones, breakout areas, and social spaces
- Constructed with a sturdy black steel tubular frame
- Finishes are exclusively made to order
- Features soft-close doors for smooth operation
- **Great as a room divider**



## Pose Wooden Storage

### POSEWS9012 // Pose Wooden Storage

Overall	D460 W900 H1200
Material	Steel
FR	Low
Weight Tolerance	15kg per shelf
RRP	£465.00

## Pose Wooden Storage

### POSEWS9018 // Pose Wooden Storage

Overall	D460 W900 H1800
Material	Steel
FR	Low
Weight Tolerance	15kg per shelf
RRP	£795.00



## Pose Wooden Storage

### POSEWS1812 // Pose Wooden Storage

Overall	D460 W1800 H1200
Material	Steel
FR	Low
Weight Tolerance	15kg per shelf
RRP	£825.00

## Pose Wooden Storage

### POSEWS1818 // Pose Wooden Storage

Overall	D460 W1800 H1800
Material	Steel
FR	Low
Weight Tolerance	15kg per shelf
RRP	£1,425.00



# Wooden Bookcases



Stocked finishes | Made to order finish:



- 18mm one piece MFC back panel
- 25mm top and bottom panels
- Black adjustable feet for levelling
- Fully adjustable shelves

Code	Shelves	Dimensions	RRP
WDS745	1	W800 D450 H730	£241.00
WDS845	1	W800 D450 H800	£248.00
WDS1245	3	W800 D450 H1200	£339.00
WDS1845	4	W800 D450 H1800	£438.00
WDS2045	4	W800 D450 H2000	£458.00

\* WDS845 not stocked in Dark Walnut but can be made to order

E&OE. All items are subject to VAT, where applicable.

# Wooden Cupboards



Stocked finishes | Made to order finish:



- 18mm one piece MFC back panel
- 25mm top and bottom panels
- Lockable doors with silver handles
- Black adjustable feet for levelling
- Fully adjustable shelves

Code	Shelves	Dimensions	RRP
WDS745CP	1	W800 D450 H730	£297.00
WDS845CP	1	W800 D450 H800	£321.00
WDS1245CP	3	W800 D450 H1200	£431.00
WDS1845CP	4	W800 D450 H1800	£569.00
WDS2045CP	4	W800 D450 H2000	£601.00

\* WDS845CP not stocked in Dark Walnut but can be made to order





## Panel Plus Cupboards

Stocked finishes | Made to order finish:



- 18mm one piece MFC back panel
- 25mm top and bottom panels
- Lockable doors with silver handles
- Black adjustable feet for levelling
- Fully adjustable shelves

Code	Shelves	Dimensions	RRP
WDS745CPWH	1	W800 D450 H730	£297.00
WDS845CPWH	1	W800 D450 H800	£321.00
WDS1245CPWH	3	W800 D450 H1200	£431.00
WDS1845CPWH	4	W800 D450 H1800	£569.00
WDS2045CPWH	4	W800 D450 H2000	£601.00

\* WDS845CPWH not stocked in Dark Walnut but can be made to order

E&OE. All items are subject to VAT, where applicable.



# Wooden Tambours



Frame finishes:

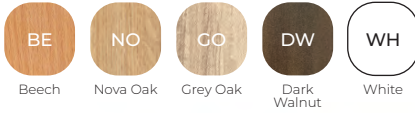

- A smooth action single silver tambour with an inset handle
- The door is lockable for security and supplied with two keys and fully adjustable shelves
- 18mm one piece MFC back panel
- 25mm top and bottom panels
- Black adjustable feet for levelling
- Shelves not supplied as standard, please contact our Sales Team for more details

Code	Dimensions	RRP
TK1050ST	W1100 D495 H1020	£1,129.00
TK2050ST	W1100 D495 H1920	£1,595.00

\* Shown with optional shelves



# Cassis Tilting Tables



Stocked top finishes | Frame finish:



Made to order top finishes:



- A mobile table with manual adjustment thumb wheels to tilt top
- Available with a silver frame
- Can be stacked or nested
- Ideal for multi-functional rooms where space is at a premium
- Lockable castors



## D-End

Code	Dimensions	RRP
OETT1470DEND	W1400 D700 H720	£500.00
OETT1680DEND	W1600 D800 H720	£532.00



## Rectangular

Code	Dimensions	RRP
OETT1270	W1200 D700 H720	£483.00
OETT1280	W1200 D800 H720	£494.00
OETT1470	W1400 D700 H720	£498.00
OETT1480	W1400 D800 H720	£513.00
OETT1670	W1600 D700 H720	£514.00
OETT1680	W1600 D800 H720	£531.00

# Cannes Tilting Tables



Stocked top finishes | Frame finish | Made to order top finishes:



- A mobile table with manual adjustment thumb wheels to tilt top
- Available with a silver frame
- Can be stacked or nested
- Ideal for multi-functional rooms where space is at a premium
- Lockable castors



## D-End

Code	Dimensions	RRP
OTT1470DEND	W1400 D700 H720	£655.00
OTT1680DEND	W1600 D800 H720	£680.00



## Rectangular

Code	Dimensions	RRP
OTT1270	W1200 D700 H720	£650.00
OTT1280	W1200 D800 H720	£650.00
OTT1470	W1400 D700 H720	£675.00
OTT1480	W1400 D800 H720	£675.00
OTT1670	W1600 D700 H720	£695.00
OTT1680	W1600 D800 H720	£695.00

# Union Folding Tables



Stocked top finishes | Frame finishes | Made to order top finishes:



- Fold flat legs for easy storage
- Chrome and silver leg options
- Legs wood screwed directly into desktop
- Ideal for multi-functional rooms where space is at a premium



## D-End

Code	Dimensions	Silver RRP	Chrome RRP
OUFF1680DEND	W1400 D700 H720	£382.00	£398.00



## Rectangular

Code	Dimensions	Silver RRP	Chrome RRP
OUFF1270	W1200 D700 H725	£333.00	£350.00
OUFF1280	W1200 D800 H725	£345.00	£361.00
OUFF1470	W1400 D700 H725	£348.00	£365.00
OUFF1480	W1400 D800 H725	£363.00	£378.00
OUFF1670	W1600 D700 H725	£364.00	£379.00
OUFF1680	W1600 D800 H725	£380.00	£395.00

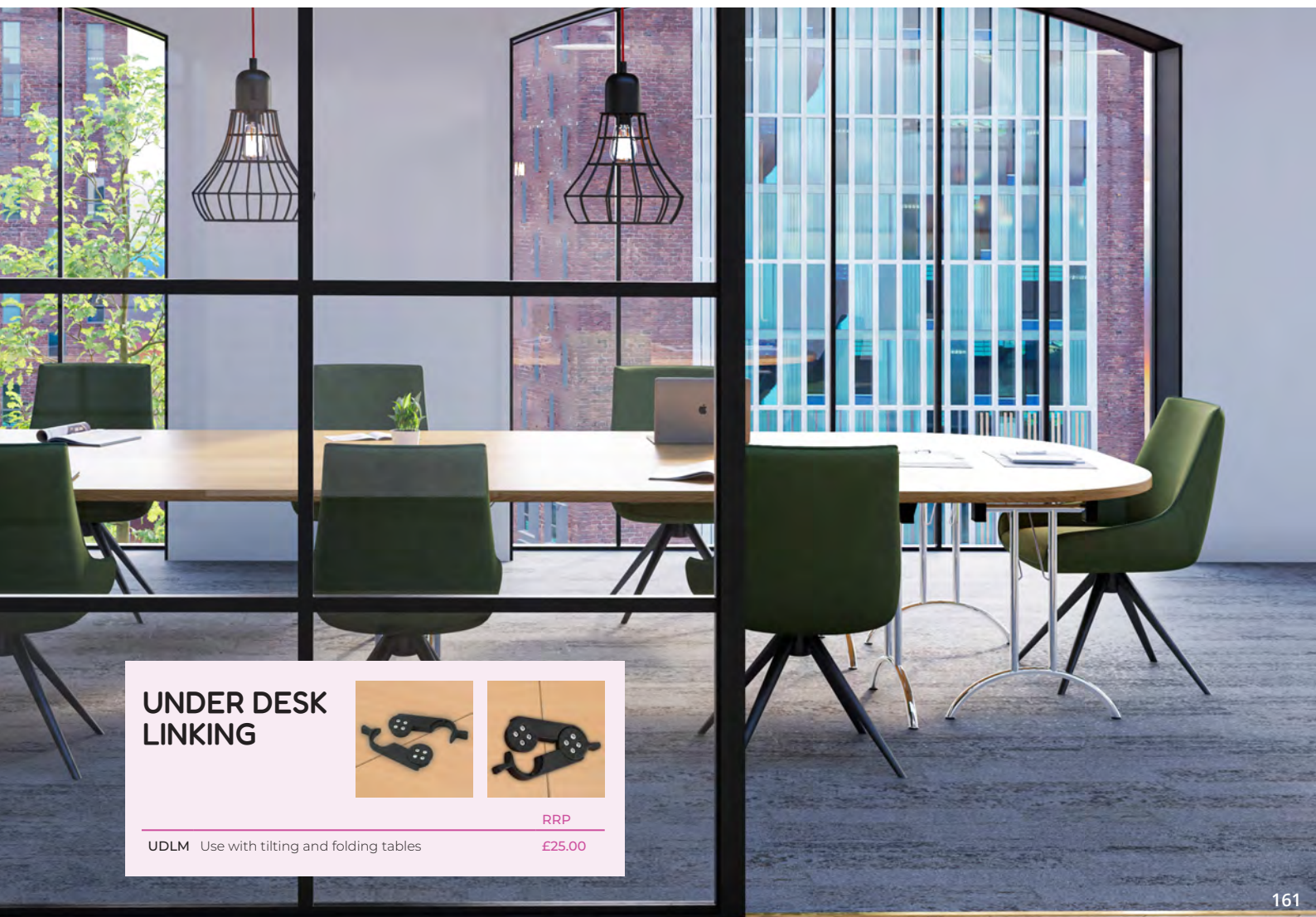

### UNDER DESK LINKING



RRP

UDLM Use with tilting and folding tables

£25.00





# Multi-purpose Tables

Stocked top finishes | Frame finish:



Made to order top finishes:



- A range of tables in three different shapes to enable you to make the best use of your space
- Flatpack frame construction
- Ideal for constructing meeting or boardroom tables of different shapes



## Rectangular Table

Code	Dimensions	RRP
OMPT1280REC	W1200 D800 H730	£215.00
OMPT1680REC	W1600 D800 H730	£218.00
OMPT1880REC	W1800 D800 H730	£239.00

## Semi-circular Table

Code	Dimensions	RRP
OMPT1680SEMI	W1600 D800 H730	£288.00



## Trapezoidal Table

Code	Dimensions	RRP
OMPT1680TRAP	W1600 D692 H730	£337.00

# Core Collection

// 02

Looking to refresh your workspace without breaking the bank? Our Core collection has you covered. Featuring stylish and practical office furniture in four contemporary colour finishes, elevate your workspace with flair and affordability.



**Like this chair?**

Versi (CH0001) in charcoal can be found on page 70



**Single Upright Bundles**  
pages 166-167



**Single Upright Cantilever Leg**  
page 169



**Double Upright Bundles**  
pages 170-171



**Double Upright Cantilever Leg**  
page 173



**Height Adjustable Desks**  
page 174



**Multi-purpose Tables**  
page 175



**Combination Cupboards**  
page 176



**Bookcases**  
page 177



**Cupboards**  
page 177



**Storage**  
page 178



**Filing Cabinets**  
page 179



**Steel Pedestal**  
page 179

#### Care & Maintenance:

Due to its resistant, hygienic and dense surface, these laminates do not require any special form of care. The surface is generally easy to clean. Do not use sanitary cleaners or detergents with abrasive components, as such cleaners may lead to changes in the gloss level and/or scratching of the material.

#### Frame Finishes

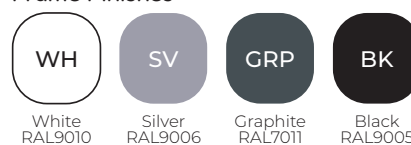

White  
RAL9010

Silver  
RAL9006

Graphite  
RAL7011

Black  
RAL9005



**Like these chairs?**  
 Calypso Mesh (CH2803) on page 81  
 Jade Armchair (OF0704) on page 79

### Single Upright Fixed Pedestal Bundle 2

Bundle includes a Single Upright 1200, 1400, 1600 or 1800 Rectangular Desk and 2 drawer fixed pedestal



Code	Dimensions	RRP
COREBUNSU1260FP2	W1200 D600 H730	£490.00
COREBUNSU1280FP2	W1200 D800 H730	£495.00
COREBUNSU1460FP2	W1400 D600 H730	£500.00
COREBUNSU1480FP2	W1400 D800 H730	£505.00
COREBUNSU1660FP2	W1600 D600 H730	£520.00
COREBUNSU1680FP2	W1600 D800 H730	£525.00
COREBUNSU1860FP2	W1800 D600 H730	£540.00
COREBUNSU1880FP2	W1800 D800 H730	£545.00



### Single Upright Fixed Pedestal Bundle 3

Bundle includes a Single Upright 1200, 1400, 1600 or 1800 Rectangular Desk and 3 drawer fixed pedestal

Code	Dimensions	RRP
COREBUNSU1260FP3	W1200 D600 H730	£490.00
COREBUNSU1280FP3	W1200 D800 H730	£495.00
COREBUNSU1460FP3	W1400 D600 H730	£500.00
COREBUNSU1480FP3	W1400 D800 H730	£505.00
COREBUNSU1660FP3	W1600 D600 H730	£520.00
COREBUNSU1680FP3	W1600 D800 H730	£525.00
COREBUNSU1860FP3	W1800 D600 H730	£540.00
COREBUNSU1880FP3	W1800 D800 H730	£545.00



# Single Upright Bundles

Stocked MFC wood finishes | Frame finishes:



**NEW**  
GRAPHITE  
FRAME  
FOR  
2025



## Single Upright Bundle 1

Bundle includes Single Upright 1600 or 1800 Radial Desk (left or right hand) and 600 deep desk high pedestal

Code	Dimensions	RRP
COREBUNSU1612L	L/H W1600 D1200 H730 D <sup>2</sup> 800	£645.00
COREBUNSU1612R	R/H W1600 D1200 H730 D <sup>2</sup> 800	£645.00
COREBUNSU1812L	L/H W1800 D1200 H730 D <sup>2</sup> 800	£685.00
COREBUNSU1812R	R/H W1800 D1200 H730 D <sup>2</sup> 800	£685.00

## Single Upright Mobile Pedestal Bundle 2

Bundle includes a Single Upright 1200, 1400, 1600 or 1800 Rectangular Desk and 2 drawer mobile pedestal

Code	Dimensions	RRP
COREBUNSU12602	W1200 D600 H730	£485.00
COREBUNSU12802	W1200 D800 H730	£490.00
COREBUNSU14602	W1400 D600 H730	£505.00
COREBUNSU14802	W1400 D800 H730	£510.00
COREBUNSU16602	W1600 D600 H730	£525.00
COREBUNSU16802	W1600 D800 H730	£530.00
COREBUNSU18602	W1800 D600 H730	£535.00
COREBUNSU18802	W1800 D800 H730	£540.00



## Single Upright Mobile Pedestal Bundle 3

Bundle includes a Single Upright 1200, 1400, 1600 or 1800 Rectangular Desk and 3 drawer mobile pedestal

Code	Dimensions	RRP
COREBUNSU12603	W1200 D600 H730	£485.00
COREBUNSU12803	W1200 D800 H730	£490.00
COREBUNSU14603	W1400 D600 H730	£505.00
COREBUNSU14803	W1400 D800 H730	£510.00
COREBUNSU16603	W1600 D600 H730	£525.00
COREBUNSU16803	W1600 D800 H730	£530.00
COREBUNSU18603	W1800 D600 H730	£535.00
COREBUNSU18803	W1800 D800 H730	£540.00





**Like this chair?**  
Calypso Mesh (CH2803)  
in charcoal can be found  
on page 71

# Single Upright Cantilever Leg



Stocked MFC wood finishes | Frame finishes:



Norwegian Beech



Canadian Oak



Alaskan Grey Oak



Arctic White



White



Silver



Graphite

**NEW**  
GRAPHITE  
FRAME  
FOR  
2025

- Available in four MFC wood finishes
- Available in three frame finishes
- 80mm cable grey ports fitted as standard
- 25mm thick desktop



## 600 Deep Rectangular Desk

Code	Dimensions	RRP
CORE8060SU	W800 D600 H730	£250.00
CORE1260SU	W1200 D600 H730	£280.00
CORE1460SU	W1400 D600 H730	£300.00
CORE1660SU	W1600 D600 H730	£320.00
CORE1860SU	W1800 D600 H730	£330.00



## 800 Deep Rectangular Desk

Code	Dimensions	RRP
CORE8080SU	W800 D800 H730	£255.00
CORE1280SU	W1200 D800 H730	£285.00
CORE1480SU	W1400 D800 H730	£305.00
CORE1680SU	W1600 D800 H730	£325.00
CORE1880SU	W1800 D800 H730	£335.00



## Radial Desk

Code	Dimensions	RRP
CORE1612LHSU	L/H W1600 D1200 H730 D <sup>2</sup> 800	£395.00
CORE1612RHSU	R/H W1600 D1200 H730 D <sup>2</sup> 800	£395.00
CORE1812LHSU	L/H W1800 D1200 H730 D <sup>2</sup> 800	£435.00
CORE1812RHSU	R/H W1800 D1200 H730 D <sup>2</sup> 800	£435.00



**Like these chairs?**  
 Versi (CH0001) on page 70  
 Jade Armchair (OF0704) and  
 Pearl Armchair (OF0705) on page 79

## Double Upright Fixed Pedestal Bundle 2

Bundle includes a Double Upright 1200, 1400, 1600 or 1800 Rectangular Desk and 2 drawer fixed pedestal

Code	Dimensions	RRP
COREBUNDU1260FP2	W1200 D600 H730	£490.00
COREBUNDU1280FP2	W1200 D800 H730	£495.00
COREBUNDU1460FP2	W1400 D600 H730	£500.00
COREBUNDU1480FP2	W1400 D800 H730	£505.00
COREBUNDU1660FP2	W1600 D600 H730	£520.00
COREBUNDU1680FP2	W1600 D800 H730	£525.00
COREBUNDU1860FP2	W1800 D600 H730	£540.00
COREBUNDU1880FP2	W1800 D800 H730	£545.00



## Double Upright Fixed Pedestal Bundle 3

Bundle includes a Double Upright 1200, 1400, 1600 or 1800 Rectangular Desk and 3 drawer fixed pedestal

Code	Dimensions	RRP
COREBUNDU1260FP3	W1200 D600 H730	£490.00
COREBUNDU1280FP3	W1200 D800 H730	£495.00
COREBUNDU1460FP3	W1400 D600 H730	£500.00
COREBUNDU1480FP3	W1400 D800 H730	£505.00
COREBUNDU1660FP3	W1600 D600 H730	£520.00
COREBUNDU1680FP3	W1600 D800 H730	£525.00
COREBUNDU1860FP3	W1800 D600 H730	£540.00
COREBUNDU1880FP3	W1800 D800 H730	£545.00



# Double Upright Bundles

Stocked MFC wood finishes | Frame finishes:



**NEW**  
GRAPHITE  
FRAME  
FOR  
2025



## Double Upright Bundle 1

Bundle includes Double Upright 1600 or 1800 Radial Desk (left or right hand) and 600 deep desk high pedestal

Code		Dimensions	RRP
COREBUNDU1612L	L/H	W1600 D1200 H730 D <sup>2</sup> 800	£645.00
COREBUNDU1612R	R/H	W1600 D1200 H730 D <sup>2</sup> 800	£645.00
COREBUNDU1812L	L/H	W1800 D1200 H730 D <sup>2</sup> 800	£685.00
COREBUNDU1812R	R/H	W1800 D1200 H730 D <sup>2</sup> 800	£685.00

## Double Upright Mobile Pedestal Bundle 2

Bundle includes a Double Upright 1200, 1400, 1600 or 1800 Rectangular Desk and 2 drawer mobile pedestal

Code	Dimensions	RRP
COREBUNDU12602	W1200 D600 H730	£485.00
COREBUNDU12802	W1200 D800 H730	£490.00
COREBUNDU14602	W1400 D600 H730	£505.00
COREBUNDU14802	W1400 D800 H730	£510.00
COREBUNDU16602	W1600 D600 H730	£525.00
COREBUNDU16802	W1600 D800 H730	£530.00
COREBUNDU18602	W1800 D600 H730	£535.00
COREBUNDU18802	W1800 D800 H730	£540.00



## Double Upright Mobile Pedestal Bundle 3

Bundle includes a Double Upright 1200, 1400, 1600 or 1800 Rectangular Desk and 3 drawer mobile pedestal



Code	Dimensions	RRP
COREBUNDU12603	W1200 D600 H730	£485.00
COREBUNDU12803	W1200 D800 H730	£490.00
COREBUNDU14603	W1400 D600 H730	£505.00
COREBUNDU14803	W1400 D800 H730	£510.00
COREBUNDU16603	W1600 D600 H730	£525.00
COREBUNDU16803	W1600 D800 H730	£530.00
COREBUNDU18603	W1800 D600 H730	£535.00
COREBUNDU18803	W1800 D800 H730	£540.00



# Double Upright Cantilever Leg



Stocked MFC wood finishes | Frame finishes:



Norwegian Beech



Canadian Oak



Alaskan Grey Oak



Arctic White



White



Silver



Graphite

**NEW**  
GRAPHITE  
FRAME  
FOR  
2025

- Available in four MFC wood finishes
- Available in three frame finishes
- 80mm cable grey ports fitted as standard
- 25mm thick desktop



## 600 Deep Rectangular Desk

Code	Dimensions	RRP
CORE8060DU	W800 D600 H730	£250.00
CORE1260DU	W1200 D600 H730	£280.00
CORE1460DU	W1400 D600 H730	£300.00
CORE1660DU	W1600 D600 H730	£320.00
CORE1860DU	W1800 D600 H730	£330.00



## 800 Deep Rectangular Desk

Code	Dimensions	RRP
CORE8080DU	W800 D800 H730	£255.00
CORE1280DU	W1200 D800 H730	£285.00
CORE1480DU	W1400 D800 H730	£305.00
CORE1680DU	W1600 D800 H730	£325.00
CORE1880DU	W1800 D800 H730	£335.00



## Radial Desk

Code	Dimensions	RRP
CORE1612LH DU	L/H W1600 D1200 H730 D <sup>2</sup> 800	£395.00
CORE1612RH DU	R/H W1600 D1200 H730 D <sup>2</sup> 800	£395.00
CORE1812LH DU	L/H W1800 D1200 H730 D <sup>2</sup> 800	£435.00
CORE1812RH DU	R/H W1800 D1200 H730 D <sup>2</sup> 800	£435.00

# Single Motor Height Adjustable



Stocked MFC wood finishes | Frame finishes:



**NEW**  
GRAPHITE  
FRAME  
FOR  
2025



- Use of standing desks increases and improves blood flow and overall health
- Adjustable feet for levelling
- Featuring an adjustment range of 730-1200mm in height
- Available in four MFC wood finishes
- Available in three frame finishes
- 25mm thick desktop

Code	Dimensions	RRP
CORESM1280CP	W1200 D800 H730 - 1200	£525.00
CORESM1480CP	W1400 D800 H730 - 1200	£535.00

# Twin Motor Height Adjustable



Stocked MFC wood finishes | Frame finishes:



**NEW**  
CONTROLLER  
FEATURES  
FOR  
2025



- Preset your two optimum working heights using the built-in memory and digital display
- Twin motor
- Anti-collision
- Adjustable feet for levelling
- Featuring an adjustment range of 645-1305mm in height
- Touch screen
- USB-A and USB-C integrated into the side of the controller

Code	Dimensions	RRP
CORED1280CP	W1200 D800 H645 - 1305	£725.00
CORED1480CP	W1400 D800 H645 - 1305	£754.00
CORED1680CP	W1600 D800 H645 - 1305	£782.00
CORED1880CP	W1800 D800 H645 - 1305	£811.00



# Multi-purpose Tables

Stocked top finishes | Frame finish:



- Available in four MFC wood finishes
- Available in one frame finish
- 25mm thick tabletop

Code	Dimensions	RRP
CORE6060MPT	W600 D600 H730	£160.00
CORE8080MPT	W800 D800 H730	£163.00
CORE1260MPT	W1200 D600 H730	£175.00
CORE1280MPT	W1200 D800 H730	£178.00
CORE1460MPT	W1400 D600 H730	£182.00
CORE1480MPT	W1400 D800 H730	£185.00
CORE1660MPT	W1600 D600 H730	£189.00
CORE1680MPT	W1600 D800 H730	£192.00
CORE1860MPT	W1800 D600 H730	£217.00
CORE1880MPT	W1800 D800 H730	£220.00



**Like these chairs?**  
 Veer (CH0629) on page 59  
 Versi (CH0001) on page 70



Like this chair?  
Calypso Mesh (CH2803)  
in charcoal can be found  
on page 71

## Combination Cupboards

Stocked MFC wood finishes:



Norwegian Beech   Canadian Oak   Alaskan Grey Oak   Arctic White



- Features a low double door cupboard topped with an open shelved section
- Upper open shelved section can be used to store files or for display purposes
- Supplied with stylish silver handles
- Soft close hinges
- Lockable cupboard doors
- Three heights to choose from to suit any space

Code	Shelves	Dimensions	RRP
CORECC1592	2 x floating / 1 x fixed	W800 D400 H1592	£350.00
CORECC1980	3 x floating / 1 x fixed	W800 D400 H1980	£465.00
CORECC2200	3 x floating / 1 x fixed	W800 D400 H2200	£550.00

# Bookcases



Stocked MFC wood finishes:



Norwegian Beech



Canadian Oak



Alaskan Grey Oak



Arctic White



- Available in four MFC wood finishes
- Floating shelves included
- Five different heights to choose from, to suit any space

Code	Shelves	Dimensions	RRP
CORE0730BKC	1	W800 D400 H730	£200.00
CORE0816BKC	1	W800 D400 H816	£217.00
CORE1204BKC	2	W800 D400 H1204	£245.00
CORE1592BKC	3	W800 D400 H1592	£310.00
CORE1980BKC	4	W800 D400 H1980	£395.00

# Cupboards



Stocked MFC wood finishes:



Norwegian Beech



Canadian Oak



Alaskan Grey Oak



Arctic White



- Available in four MFC wood finishes
- Soft close hinges
- Five different heights to choose from, to suit any space

Code	Shelves	Dimensions	RRP
CORE0730CBD	1	W800 D400 H730	£250.00
CORE0816CBD	1	W800 D400 H816	£260.00
CORE1204CBD	2	W800 D400 H1204	£299.00
CORE1592CBD	3	W800 D400 H1592	£380.00
CORE1980CBD	4	W800 D400 H1980	£500.00

# Storage



Stocked MFC wood finishes:



## 2 Drawer Under Desk Mobile Pedestal

Code	Dimensions	RRP
COREUDM2	W400 D500 H590	£205.00

## 3 Drawer Under Desk Mobile Pedestal

Code	Dimensions	RRP
COREUDM3	W400 D500 H590	£205.00

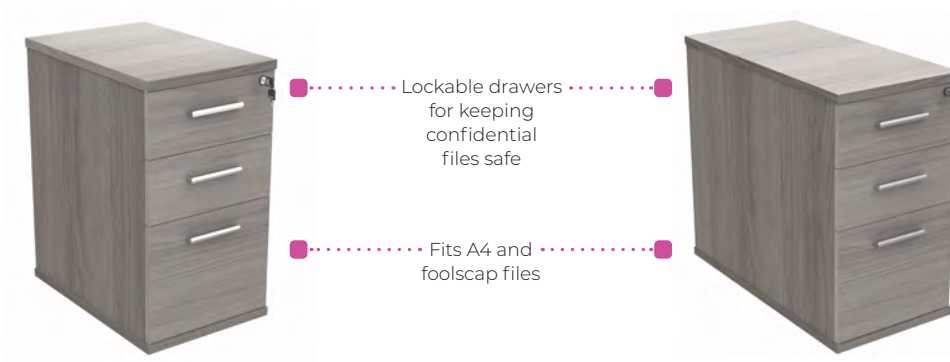

## 600 Depth Desk High Pedestal

Code	Dimensions	RRP
CORED3600	W400 D600 H730	£250.00

## 800 Depth Desk High Pedestal

Code	Dimensions	RRP
CORED3800	W400 D800 H730	£290.00



## 2 Drawer Under Desk Fixed Pedestal

Code	Dimensions	RRP
COREFP2/600	W394 D430 H490	£175.00

## 3 Drawer Under Desk Fixed Pedestal

Code	Dimensions	RRP
COREFP3/600	W394 D430 H490	£185.00

# Filing Cabinets



Stocked MFC wood finishes:



- Available in four MFC wood finishes
- Lockable drawers for keeping confidential files safe
- Fits A4 and foolscap files

Code	Drawers	Dimensions	RRP
CORE2FC	2	W460 D600 H707	£283.00
CORE3FC	3	W460 D600 H1034	£390.00
CORE4FC	4	W460 D600 H1358	£435.00

# Steel Pedestal



Steel finishes:



- Mobile under desk steel pedestal
- Available in three steel finishes
- Lockable drawers for keeping confidential files safe
- Fits A4 and foolscap files

Code	Dimensions	RRP
COREUSMP3	W400 D800 H730	£240.00

# Screens & Panels

// 02

Elevate your workspace with our versatile screens and panels! Perfect for dividing spaces, creating collaborative areas, or setting up focused work zones.



**Like this chair?**  
Zest chair - call for more details



**Contempo Screens**  
page 182



**Elco Screens**  
page 183

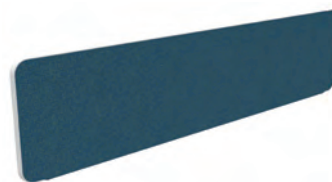

**Lyle Screens**  
page 184

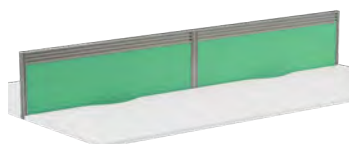

**Toolrail Screens**  
page 185



**Panel Screens**  
page 186



**Screen Accessories**  
page 187



**Tone**  
page 188



**Magnum Screens**  
page 189



**Divide Type 1 Screens**  
page 190



**Divide Type 2 Screens**  
page 191



**Mobile Screens**  
page 193

# Contempo Screens



Finish:



Unlimited

- Priced in Band 3 fabric
- Beautifully detailed exposed stitching
- Fully upholstered in fire retardant fabric
- Hand crafted
- Screen thickness 25mm (approx)

**IMPORTANT NOTE:** Contempo screens are only available in Blazer Lite fabric

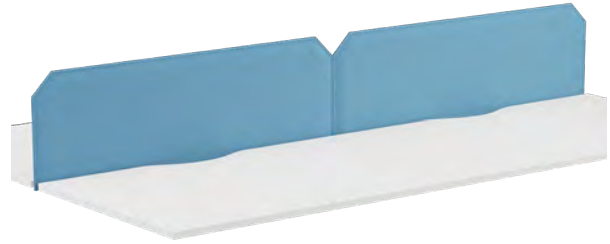

## Type 1 - Rounded

Code	Dimensions	RRP
TKT1COSY12UN	W1200 H380	£320.00
TKT1COSY14UN	W1400 H380	£335.00
TKT1COSY16UN	W1600 H380	£379.00

## Type 3 - Chamfer

Code	Dimensions	RRP
TKT3COSY12UN	W1200 H380	£320.00
TKT3COSY14UN	W1400 H380	£335.00
TKT3COSY16UN	W1600 H380	£379.00



## Contempo, Elco & Lyle Brackets

- These are fitted with a 'metal-to-screen' connection bracket and require 2 x TKDMSTRSC per screen

Code	RRP
TKDMSTRSC	£27.00





# Elco Screens



Finish:



Unlimited

- Priced in Band 1 fabric
- Defines the working zone on bench and desk systems
- Allows privacy, increasing productivity
- 25mm screen thickness
- Fully upholstered screen in fire retardant fabric with matching trim
- Accessory hanging facility available, see page 187
- Rounded on all corners
- Superior build quality
- Grip is simple and fast to reposition - no bracket needed



## Straight

Code	Dimensions	RRP
TKDMSECST12UN	W1200 H380	£218.00
TKDMSECST14UN	W1400 H380	£231.00
TKDMSECST16UN	W1600 H380	£265.00



## Arc

Code	Dimensions	RRP
TKDMSECA12UN	W1200 H380	£218.00
TKDMSECA14UN	W1400 H380	£231.00
TKDMSECA16UN	W1600 H380	£265.00



## Grip

Code	RRP
TKDMSECGR60UN	£302.00



# Lyle Screens



Fabric finish | Made to order trim finishes:



Unlimited

White

Silver

- Priced in Band 1 fabric
- See page 185 for brackets

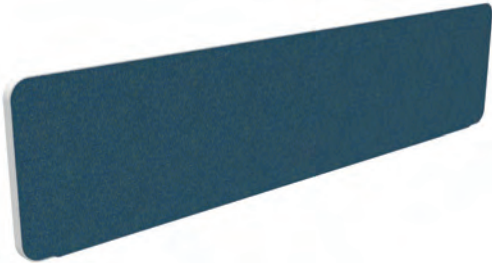

## Straight

Code	Dimensions	RRP
TKDMSLYST10UN	W1000 H380	£151.00
TKDMSLYST12UN	W1200 H380	£167.00
TKDMSLYST14UN	W1400 H380	£175.00
TKDMSLYST16UN	W1600 H380	£206.00



## Wave

Code	Dimensions	RRP
TKDMSLYWV10UN	W1000 H380	£151.00
TKDMSLYWV12UN	W1200 H380	£167.00
TKDMSLYWV14UN	W1400 H380	£175.00
TKDMSLYWV16UN	W1600 H380	£206.00



## Arc

Code	Dimensions	RRP
TKDMSLYA10UN	W1200 H380	£151.00
TKDMSLYA12UN	W1400 H380	£167.00
TKDMSLYA14UN	W1600 H380	£175.00
TKDMSLYA16UN	W1600 H380	£206.00





# Toolrail Screens

Fabric finish | Made to order trim finishes:



- \* Top section will be silver on the black trim finish
- Priced in Band 1 fabric
- See below for brackets

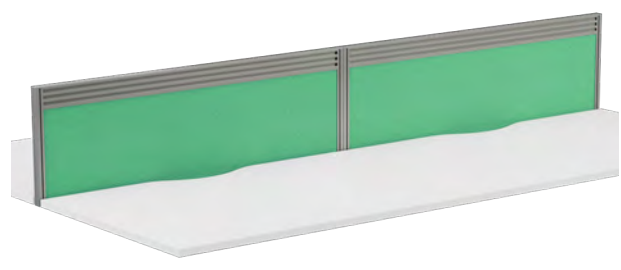

## Type 2 Toolbar

Code	Dimensions	RRP
TKDMSTR12UN	W1200 H380	£232.00
TKDMSTR14UN	W1400 H380	£262.00
TKDMSTR16UN	W1600 H380	£293.00

## Type 2 Return Toolbar

Code	Dimensions	RRP
TKDMSTR80RUN	W785 H380	£196.00

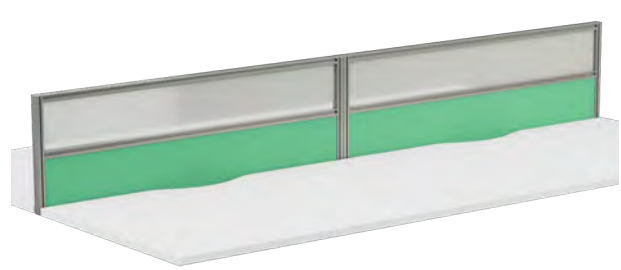

## Type 3 Half Glazed

Code	Dimensions	RRP
TKDMSHG12UN	W1200 H380	£312.00
TKDMSHG14UN	W1400 H380	£337.00
TKDMSHG16UN	W1600 H380	£365.00

## Type 3 Return Half Glazed

Code	Dimensions	RRP
TKDMSHG80RUN	W785 H380	£258.00

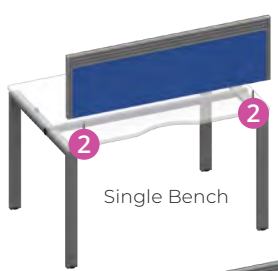

Single Bench

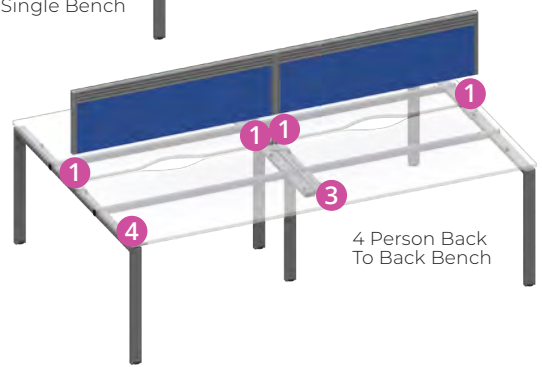

4 Person Back To Back Bench

## Toolrail & Panel Brackets

These are fitted with 'metal-to-metal' connection brackets as follows:

- 1 Back to Back Bench requires 1 x TKDMSENDSCP per screen (come in pairs)
- 2 Single Bench requires 2 x TKDMSTRSC per screen

Toolrail & Panel can be fitted as return screens on Bench. Each return screen requires brackets as follows:

- 3 Mid run return screens require 1 x TKDMSRETSCB, which includes 1 x TKDMSRETSC to clamp the leading edge of the screen and 1 x TKSLINKKIT to join the return screen to the spine screens
- 4 End of run return screens require 1 x TKDMSRETEORSCB, which includes 1 x TKDMSRETEORSC and 1 x TKSLINKKIT

Code	RRP
TKDMSENDSCP	£50.00
TKDMSTRSC	£27.00
TKDMSRETSCB	£52.00
TKDMSRETEORSCB	£28.00



# Panel Screens

Fabric finish | Made to order trim finishes:



Unlimited

White

Silver

Black

\* Top section will be silver on the black trim finish

· Priced in Band 1 fabric

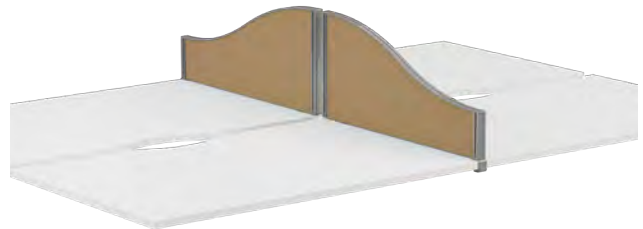

## Type 5 Wave

Code	Dimensions	RRP
TKDMSW12UN	W1200 H380	£202.00
TKDMSW14UN	W1400 H380	£214.00
TKDMSW16UN	W1600 H380	£246.00

## Type 5 Return Wave

Code	Dimensions	RRP
TKDMSW80RUN	W785 H380	£172.00

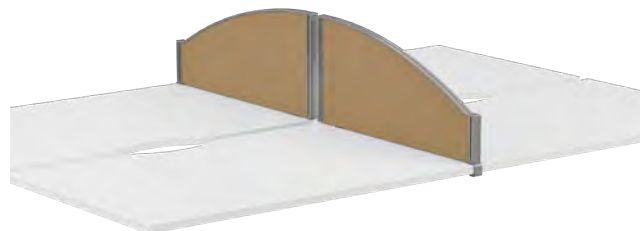

## Type 6 Arc

Code	Dimensions	RRP
TKDMSA12UN	W1200 H380	£202.00
TKDMSA14UN	W1400 H380	£214.00
TKDMSA16UN	W1600 H380	£247.00

## Type 6 Return Arc

Code	Dimensions	RRP
TKDMSA80RUN	W785 H380	£168.00



## Type 7 Straight PVC Top

Code	Dimensions	RRP
TKDMSP12	W1200 H380	£189.00
TKDMSP14	W1400 H380	£197.00
TKDMSP16	W1600 H380	£224.00

## Type 7 Return Straight PVC Top

Code	Dimensions	RRP
TKDMSP80RUN	W785 H380	£158.00



# Screen Accessories

Made to order finishes:



- \* Top section will be silver on the black trim finish
- Priced in Band 1 fabric

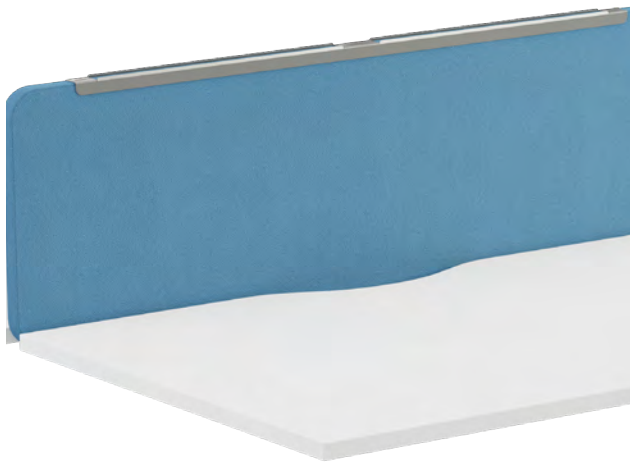

## Accessory Rail

- Handy accessory rail simply slots over the top of a straight screen, allowing screen accessories to be utilised
- Available in 5 different widths to suit varying screen sizes
- Epoxy powder coated to match desk frames

**NOTE:** Sizes are to suit screen size - actual lengths are 200mm shorter

Code	Rail Width	To Fit Screen Width	RRP
TKDMSTR08AR	W600	W800	£37.00
TKDMSTR10AR	W800	W1000	£41.00
TKDMSTR12AR	W1000	W1200	£43.00
TKDMSTR14AR	W1200	W1400	£47.00
TKDMSTR16AR	W1400	W1600	£61.00



Pencil Pot



Trinket Pot



Phone Holder



Letter Tray

## Toolrail Accessories

- A unique set of screen hung accessories to provide personal storage above the desk
- All accessories can be hung from the Elco accessory rail and Toolrail screens
- The phone holder is compatible with a wide range of smartphones
- The pencil and trinket pots help tidy workspaces by lifting personal effects off the desktop
- Available in white, silver or black finish

Code		RRP
TKDMSTRPTA4	A4 Letter Tray	£43.00
TKDMSTRPEN	Pencil Pot	£30.00
TKDMSTRTP	Trinket Pot	£29.00
TKDMSTRPH	Phone Holder	£29.00



# Tone

Finish:



Unlimited

Enhance focus and reduce noise. Designed to absorb sound and create a quieter workspace, these panels improve the overall office environment, boosting productivity and comfort in busy areas.



## Desk Mounted Screens

Acoustic desk-mounted screens reduce noise and distractions creating a quieter, more focused workspace whilst adding privacy and style.

49mm thick desk mounted frameless (non-linking) sound absorbing screen

Code	Dimensions	RRP
TONE14UN	W800 H500	£445.00
TONE15UN	W1000 H500	£500.00
TONE16UN	W1200 H500	£530.00
TONE17UN	W1400 H500	£555.00
TONE18UN	W1600 H500	£615.00
TONE19UN	W1800 H500	£640.00
TONE20UN	W800 H600	£465.00
TONE21UN	W1000 H600	£520.00
TONE22UN	W1200 H600	£550.00
TONE23UN	W1400 H600	£575.00
TONE24UN	W1600 H600	£635.00
TONE25UN	W1800 H600	£660.00



## Wall Tiles

Our frameless acoustic wall panels absorb sound, reduce echoes, and improve acoustics, offering a sleek, functional solution for noise control.

Hexagonal Wall Tile			
	Code	Dimensions	RRP
Small	TONE1UN	W500 H433	£235.00
Medium	TONE2UN	W700 H606	£265.00
Large	TONE3UN	W900 H779	£295.00
Square Wall Tile			
Small	TONE4UN	W600 H600	£250.00
Medium	TONE5UN	W800 H800	£285.00
Large	TONE6UN	W1200 H1200	£395.00
Rectangular Wall Tile			
Small	TONE8UN	W800 H1600	£410.00
Large	TONE7UN	W1200 H1600	£475.00



## Ceiling Hung Tiles

Our frameless acoustic wall panels absorb sound, reduce echoes, and improve acoustics, offering a sleek, functional solution for noise control.

Circular Ceiling Hung Tile			
	Code	Dimensions	RRP
Small	TONE10UN	W800 H1600	£650.00
Large	TONE9UN	W1200 H1600	£715.00
Circular Ceiling Hung Tile			
Small	TONE12UN	W800 H800	£525.00
Large	TONE11UN	W1200 H1200	£630.00
Circular Ceiling Hung Tile			
Large	TONE13UN	W1200 H1200	£640.00



# Magnum Screens

Finishes:



Royal Blue



Black

- Strong and durable construction
- Made from fire retardant materials
- G-clamp brackets included with the Straight Screen
- Feet included with the Floor Standing Screen



## Straight Screen

Code	Dimensions	RRP
DMS1200S	W1200 D25 H400	£124.00
DMS1400S	W1400 D25 H400	£132.00
DMS1600S	W1600 D25 H400	£138.00
DMS1800S	W1800 D25 H400	£149.00



## Floor Standing Screen

Code	Dimensions	RRP
FST1216S	W1200 D25 H1600	£268.00
FST1218S	W1200 D25 H1800	£295.00
FST1412S	W1400 D25 H1200	£232.00
FST1416S	W1400 D25 H1600	£293.00
FST1418S	W1400 D25 H1800	£322.00
FST1612S	W1600 D25 H1200	£250.00
FST1616S	W1600 D25 H1600	£317.00
FST1618S	W1600 D25 H1800	£350.00



## Divide Type 1 Screen - Single Toolrail



Fabric finish | Made to order trim finishes:



\* Top section will be silver on the black trim finish

• Priced in Band 1 fabric



- 30mm screen thickness
- Robust, lightweight aluminium extruded frame
- Fully upholstered in fire retardant fabric
- Straight top screen profile
- Integral linking strip
- Epoxy powder coated frame available in white, silver or black as standard
- Delta feet required to stabilise screen

Code	Dimensions	RRP	Code	Dimensions	RRP
TKFST1Z0810UN	W800 H1071	£493.00	TKFST1Z0815UN	W800 H1500	£515.00
TKFST1Z1010UN	W1000 H1071	£558.00	TKFST1Z1015UN	W1000 H1500	£590.00
TKFST1Z1210UN	W1200 H1071	£558.00	TKFST1Z1215UN	W1200 H1500	£590.00
TKFST1Z1410UN	W1400 H1071	£602.00	TKFST1Z1415UN	W1400 H1500	£604.00
TKFST1Z1610UN	W1600 H1071	£602.00	TKFST1Z1615UN	W1600 H1500	£604.00
TKFST1Z1810UN	W1800 H1071	£656.00	TKFST1Z1815UN	W1800 H1500	£658.00
TKFST1Z0812UN	W800 H1200	£493.00	TKFST1Z0818UN	W800 H1800	£602.00
TKFST1Z1012UN	W1000 H1200	£558.00	TKFST1Z1018UN	W1000 H1800	£634.00
TKFST1Z1212UN	W1200 H1200	£558.00	TKFST1Z1218UN	W1200 H1800	£634.00
TKFST1Z1412UN	W1400 H1200	£602.00	TKFST1Z1418UN	W1400 H1800	£646.00
TKFST1Z1612UN	W1600 H1200	£602.00	TKFST1Z1618UN	W1600 H1800	£646.00
TKFST1Z1812UN	W1800 H1200	£656.00	TKFST2ZDFOOT	Delta foot (each)	£53.00

E&OE. All items are subject to VAT, where applicable.





# Divide Type 2 Screen - Triple Toolrail

Fabric finish | Made to order trim finishes:



Unlimited



White



Silver



Black

\* Top section will be silver on the black trim finish

· Priced in Band 1 fabric



- 30mm screen thickness
- Robust, lightweight aluminium extruded frame
- Fully upholstered in fire retardant fabric
- Straight top screen profile
- Integral linking strip
- Epoxy powder coated frame available in white, silver or black as standard
- Delta feet required to stabilise screen

Code	Dimensions	RRP
TKFST2Z0810UN	W800 H1071	£512.00
TKFST2Z1010UN	W1000 H1071	£586.00
TKFST2Z1210UN	W1200 H1071	£586.00
TKFST2Z1410UN	W1400 H1071	£641.00
TKFST2Z1610UN	W1600 H1071	£641.00
TKFST2Z1810UN	W1800 H1071	£712.00
TKFST2ZDFOOT	Delta foot (each)	£53.00





Handwritten notes and diagrams on the whiteboard, including flowcharts, graphs, and text. The text is in German and appears to be a project plan or technical drawing. Key phrases include "Projektplan", "Ziele", "Maßnahmen", "Risikoanalyse", "Kunden", "Anbieter", "Zeitplan", "Kosten", "Ressourcen", "Kommunikation", "Bericht", "Mitarbeiter", "Kunden", "Anbieter", "Zeitplan", "Kosten", "Ressourcen", "Kommunikation", "Bericht", "Mitarbeiter".

# Mobile Screens

Fabric finish | Made to order trim finishes:



- \* Top section will be silver on the black trim finish
- Priced in Band 1 fabric
- 30mm screen thickness
- Robust, lightweight aluminium extruded frame
- Fully upholstered in fire retardant fabric
- Trim mounted mobile feet included
- Epoxy powder coated frame available in white, silver or black as standard



## Type 1 - Single Toolrail

Code	Dimensions	RRP
TKT1SKT0815UN	W800 H1500	£799.00
TKT1SKT1015UN	W1000 H1500	£912.00
TKT1SKT0818UN	W800 H1800	£800.00
TKT1SKT1018UN	W1000 H1800	£980.00

## Type 2 - Triple Toolrail

Code	Dimensions	RRP
TKT2SKT0815UN	W800 H1500	£818.00
TKT2SKT1015UN	W1000 H1500	£940.00
TKT2SKT0818UN	W800 H1800	£820.00
TKT2SKT1018UN	W1000 H1800	£1,009.00



## Type 3 - Half Glazed

Code	Dimensions	RRP
TKT3SKT0815UN	W800 H1500	£884.00
TKT3SKT1015UN	W1000 H1500	£951.00
TKT3SKT0818UN	W800 H1800	£953.00
TKT3SKT1018UN	W1000 H1800	£1,087.00

## Type 4 - Fully Glazed

Code	Dimensions	RRP
TKT4SKT0815UN	W800 H1500	£987.00
TKT4SKT1015UN	W1000 H1500	£1,024.00
TKT4SKT0818UN	W800 H1800	£1,046.00
TKT4SKT1018UN	W1000 H1800	£1,084.00

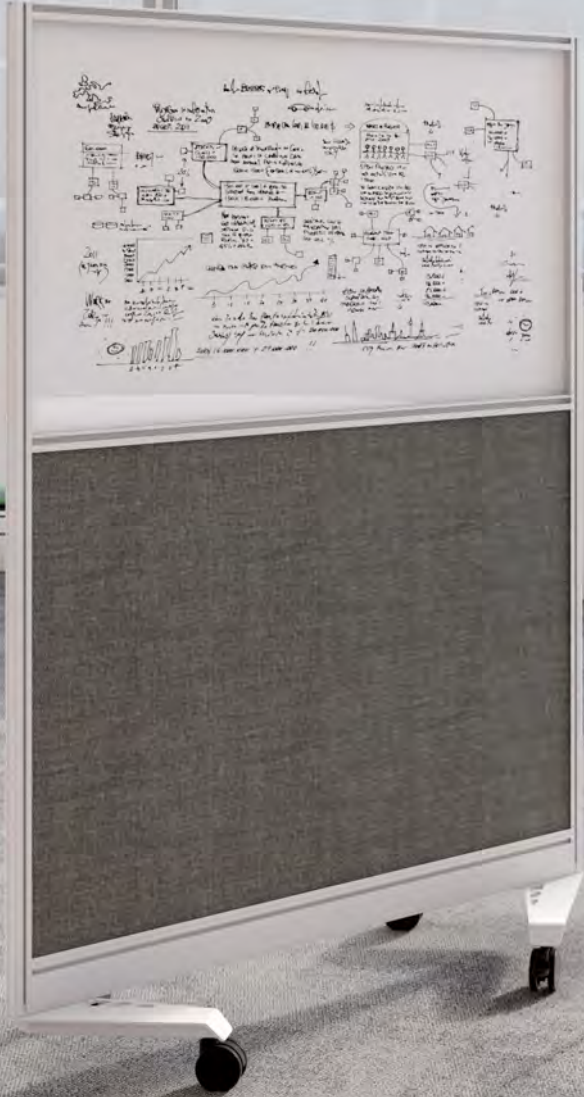

# Screen Finish Guide

Too much choice? Let us help you with that. Whether it's a Granite grey, an Ocean blue or a Jezebel red; we've created a guide to help you pick your perfect fabric.

Should you need more information regarding screen finishes and their application, please give the sales team a call.

## Toolrail / Panel / Divide / Mobile / Lyle Screens

Screen Fabric Bands				
Band 1	Band 2	Band 3	Band 4	Band 5
Cara	Lucia	Nexus	24/7 Flax	Blazer
Phoenix	Sonus	Main Line Plus	Mainline Flax	Aquarius
Era	Advantage	Aspect	Hi-Tech	Track
Citadel	Manhattan		Synergy	Silk
Rivet	Canopy		Hemp	Synergy 170
Gravity	Sprint		Intervene Texture	
	Xtreme		Intervene Plain	
	Chateau		Blazer Lite	
	X2			
	Urban			

NOTE: Grip screens are not available in Sonus fabric

## Elco Screens

Screen Fabric Bands				
Band 1	Band 2	Band 3	Band 4	Band 5
Cara	Lucia	Nexus	Blazer Lite	Synergy 170
Era				

## Contempo Screens

Screen Fabric Bands			
Band 1	Band 2	Band 3	Band 4
N/A	N/A	N/A	Blazer Lite

## Perspex Selection

	Colour	Toolrail	Divide	Mobile
Solid fill	Aurora Violet	✓	✓	✓
	Perfect Plum	✓	✓	✓
	Citrus Yellow	✓	✓	N/A
	Chilli Red	✓	✓	✓
	Mandarin Orange	✓	✓	✓
	Lime Zest	✓	✓	✓
	Opal (drywipe)	N/A	N/A	✓
Opaque	Glacier Green	✓	✓	✓
	Electric Blue	✓	✓	✓
	Polar White	✓	✓	✓
	Slate Grey	✓	✓	✓

NOTE: For whiteboard use, please select the Opal perspex as this is the only dry wipe finish

# Meeting Tables

// 03

Create a fantastic space to collaborate with our meeting tables! From presentations to meetings, transform your space into the ultimate hub for creativity and teamwork.



**Like this table?**  
Fraction Infinity Table  
found on page 205



**Maker**  
page 199



**Plateau**  
pages 200-203



**Fraction Infinity**  
page 205



**Multi-purpose**  
page 205



**Mobile**  
page 206



**Contract**  
page 207



**Cassis Tilting**  
page 208



**Cannes Tilting**  
page 208



**Union Folding**  
page 209



**Synergy**  
page 211



**Sierra One**  
page 212



**Guarda**  
page 213



**Like these chairs?**

Arc 4 Leg chair (TA1) can be found on page 289  
and Kona High Stool on page 81



# Maker Tables



Made to order top finishes:



Frame finishes:



- Available in two heights
- KD design
- Metal to metal fixings for added strength
- ABS edge band



## Low Maker Tables

Code	Dimensions
T-LOW-M-1210	W1200 D1000 H740
T-LOW-M-1510	W1500 D1000 H740
T-LOW-M-1810	W1800 D1000 H740

## Low Maker Tables Mobile

Code	Dimensions
T-LOW-MM-1210	W1200 D1000 H740
T-LOW-MM-1510	W1500 D1000 H740
T-LOW-MM-1810	W1800 D1000 H740



## High Maker Tables

Code	Dimensions
T-HIGH-M-1210	W1200 D1000 H1100
T-HIGH-M-1510	W1500 D1000 H1100
T-HIGH-M-1810	W1800 D1000 H1100

## High Maker Tables Mobile

Code	Dimensions
T-HIGH-MM-1210	W1200 D1000 H1100
T-HIGH-MM-1510	W1500 D1000 H1100
T-HIGH-MM-1810	W1800 D1000 H1100



### Low Stool

Code		Dimensions	RRP
SPS-LSTL	Plain	W405 D405 H500	£581.00
SPS-LSTL-BTN	Button	W405 D405 H500	£620.00

### Low Bench

Code		Dimensions	RRP
SP-SPS-N	Plain	W1180 D405 H500	£942.00
SP-N-BTN	Button	W1180 D405 H500	£1,059.00



# Plateau

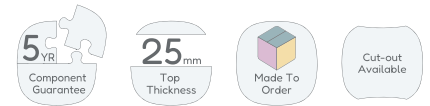

Made to order top finishes:



Frame finish:



- Stylish, modern and practical design, with wooden accents that enhance meeting and breakout spaces
- Tables feature sleek, wooden legs and a range of 8 contemporary top finishes
- Available with black wooden leg, please contact sales for more information



## Round Meeting Tables

Code	Dimensions	RRP
ZPLA1200D	W1200 D1200 H740	£1,397.00
ZPLA1400D	W1400 D1400 H740	£1,753.00



## Square Meeting Tables

Code	Dimensions	RRP
ZPLA1414S	W1400 D1400 H740	£1,922.00
ZPLA1616S	W1600 D1600 H740	£1,936.00



## Rectangular Meeting Tables

Code	Dimensions	RRP
ZPLA1680R	W1600 D800 H740	£1,359.00
ZPLA1890R	W1800 D900 H740	£1,368.00
ZPLA2010R	W2000 D1000 H740	£1,502.00
ZPLA2210R	W2200 D1000 H740	£1,507.00
ZPLA2412R	W2400 D1200 H740	£1,891.00



## Barrel Meeting Tables

Code	Dimensions	RRP
ZPLA2010B	W2000 D1000 H740	£1,591.00
ZPLA2412B	W2400 D1200 H740	£1,936.00



# Plateau High



Made to order top finishes:



Frame finish:

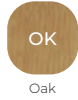

- Stylish, modern and practical design, with wooden accents that enhance meeting and breakout spaces
- Tables feature sleek, wooden legs and a range of 8 contemporary top finishes
- Available with black wooden leg, please contact sales for more information



## High Tables

Code	Dimensions	RRP
ZPLAP1410R	W1400 D1000 H1106	£1,813.00
ZPLAP1610R	W1600 D1000 H1106	£1,816.00
ZPLAP1810R	W1800 D1000 H1106	£1,818.00
ZPLAP2010R	W2000 D1000 H1106	£1,819.00
ZPLAP2210R	W2200 D1000 H1106	£1,822.00
ZPLAP2410R	W2400 D1000 H1106	£1,823.00

Fabric finish:



Unlimited



## High Stools

Code		Dimensions	RRP
SP-SPS-HSTL	Plain	W375 D375 H830	£914.00
SP-SPS-HSTL-BTN	Button	W375 D375 H830	£952.00



# Fraction Infinity Tables

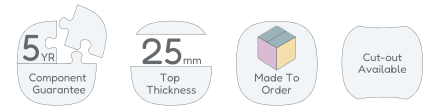

Stocked top finishes | Stocked frame finishes



Made to order top finishes | Made to order frame finish



- A modern twist on the traditional 4 leg table
- Intermediate legs facilitate larger tables to support teams working together or collaborative spaces
- Bespoke sizes available, please speak to our Sales Team for further information



## Rectangular Meeting Tables

Code	Dimensions	RRP
ZFIMT1480	W1400 D800 H740	£603.00
ZFIMT1680	W1600 D800 H740	£645.00
ZFIMT1880	W1800 D800 H740	£656.00
ZFIMT2010	W2000 D1000 H740	£723.00
ZFIMT2412	W2400 D1200 H740	£934.00
* ZFIMT2812	W2800 D1200 H740	£1,425.00
* ZFIMT3212	W3200 D1200 H740	£1,585.00
* ZFIMT3612	W3600 D1200 H740	£1,715.00
* ZFIMT4012	W4000 D1200 H740	£1,850.00

## Square Meeting Tables

Code	Dimensions	RRP
ZFIMT1212	W1200 D1200 H740	£621.00
ZFIMT1414	W1400 D1400 H740	£707.00
ZFIMT1616	W1600 D1600 H740	£773.00

\* All finishes made to order

# Multi-purpose Tables

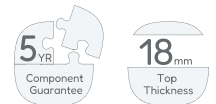

Stocked top finishes | Stocked frame finish:



Made to order top finishes:



## Rectangular Tables

Code	Dimensions	RRP
OMPT1280REC	W1200 D800 H730	£215.00
OMPT1680REC	W1600 D800 H730	£218.00
OMPT1880REC	W1800 D800 H730	£239.00

## Semi-circular Table

Code	Dimensions	RRP
OMPT1680SEMI	W1600 D800 H730	£288.00

## Trapezoidal Table

Code	Dimensions	RRP
OMPT1680TRAP	W1600 D692 H730	£337.00



## Mobile Tables



Top finishes:



Frame finishes:



### 600 Mobile

Code	Dimensions
T-MOBILE-1260	W1200 D600 H733
T-MOBILE-1460	W1400 D600 H733
T-MOBILE-1660	W1600 D600 H733
T-MOBILE-1860	W1800 D600 H733



### 800 Mobile

Code	Dimensions
T-MOBILE-1280	W1200 D800 H733
T-MOBILE-1480	W1400 D800 H733
T-MOBILE-1680	W1600 D800 H733
T-MOBILE-1880	W1800 D800 H733



# Contract Meeting Tables



Stocked top finishes:



Frame finish:



## Single

Code	Dimensions	RRP
OCMT10D	W1000 D1000 H725	£585.00
OCMT12D	W1400 D800 H733	£684.00

## Double

Code	Shape	Dimensions	RRP
OCMT1010	Square	W1000 D1000 H725	£560.00
OCMT1880	Rectangular	W1800 D800 H733	£965.00
OCMT2410RAD	Oval	W2400 D1000 H725	£1,125.00



# Cassis Tilting Tables



Stocked top finishes | Frame finish | Made to order top finishes:



- A mobile table with manual adjustment thumb wheels to tilt top
- Available with a silver frame
- Can be nested together for storage
- Ideal for multi-functional rooms where space is at a premium
- Lockable castors



## D-End

Code	Dimensions	RRP
OETT1470DEND	W1400 D700 H720	£500.00
OETT1680DEND	W1600 D800 H720	£532.00



## Rectangular

Code	Dimensions	RRP
OETT1270	W1200 D700 H720	£483.00
OETT1280	W1200 D800 H720	£494.00
OETT1470	W1400 D700 H720	£498.00
OETT1480	W1400 D800 H720	£513.00
OETT1670	W1600 D700 H720	£514.00
OETT1680	W1600 D800 H720	£531.00

# Cannes Tilting Tables



Stocked top finishes | Frame finish | Made to order top finishes:



- A mobile table with manual adjustment thumb wheels to tilt top
- Available with a silver frame
- Can be nested together for storage
- Ideal for multi-functional rooms where space is at a premium
- Lockable castors



## D-End

Code	Dimensions	RRP
OTT1470DEND	W1400 D700 H720	£655.00
OTT1680DEND	W1600 D800 H720	£680.00



## Rectangular

Code	Dimensions	RRP
OTT1270	W1200 D700 H720	£650.00
OTT1280	W1200 D800 H720	£650.00
OTT1470	W1400 D700 H720	£675.00
OTT1480	W1400 D800 H720	£675.00
OTT1670	W1600 D700 H720	£695.00
OTT1680	W1600 D800 H720	£695.00



# Union Folding Tables

Stocked top finishes | Frame finishes | Made to order top finishes:



- Fold flat legs for easy storage
- Chrome and silver leg options
- Can be stacked together for storage
- Legs wood-screwed directly into desktop
- Ideal for multi-functional rooms where space is at a premium



## D-End

Code	Dimensions	RRP	
		Silver	Chrome
OUFF1680DEND	W1400 D700 H720	£382.00	£398.00



## Rectangular

Code	Dimensions	RRP	
		Silver	Chrome
OUFF1270	W1200 D700 H725	£333.00	£350.00
OUFF1280	W1200 D800 H725	£345.00	£361.00
OUFF1470	W1400 D700 H725	£348.00	£365.00
OUFF1480	W1400 D800 H725	£363.00	£378.00
OUFF1670	W1600 D700 H725	£364.00	£379.00
OUFF1680	W1600 D800 H725	£380.00	£395.00

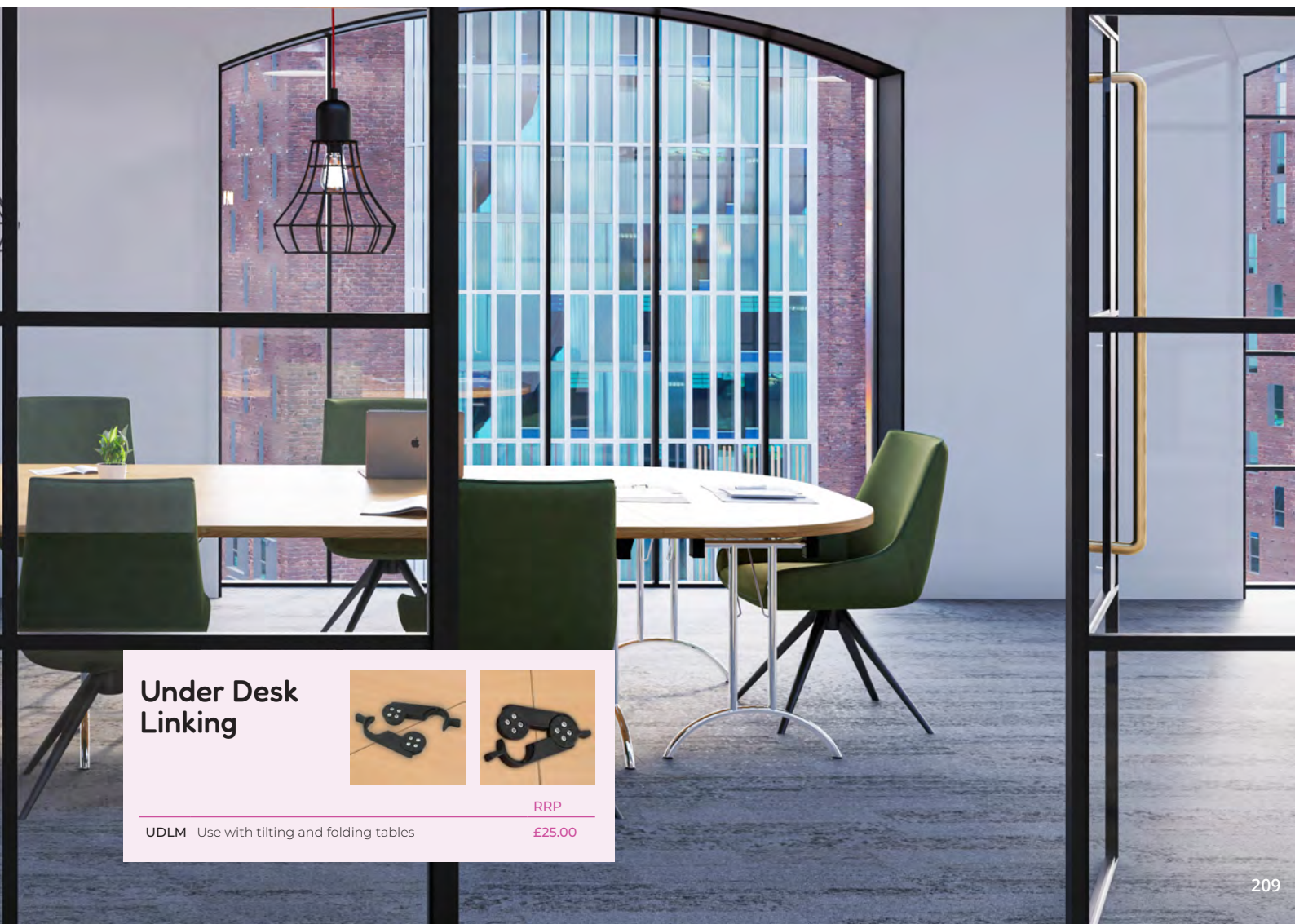

## Under Desk Linking



RRP

UDLM Use with tilting and folding tables

£25.00



# Synergy Meeting Tables



Made to order top finishes:



Made to order frame finishes:



- Combining contemporary design and practical functionality
- Ideal for meetings, creative sessions, presentations, and team discussions
- All meeting tables are made to order
- Aztec finishes will be provided as two separate tops, wood grains will align closely, but not perfectly
- Egger (UN) and Kronospan (UN) finishes will be provided in one piece up to 2800 wide, wood grains will align closely, but not perfectly



## A-Frame Meeting Table

- The A-frame structure offers a modern, sleek appearance while ensuring stability with a strong, balanced frame design
- Easily adaptable for various meeting sizes and setups
- Can be customised with power module cut outs. Please add £25 (RRP) per cut out required

**Desk Depths:** 1600mm

**Desk Widths:** 2000, 2400, 2800, 3200, 3600mm



## Goalpost Meeting Table

- The goalpost frame provides robust support, ensuring the table remains stable even with heavy use.
- Spacious table top accommodates multiple participants, technology, and paperwork comfortably.
- Can be customised with power module cut outs. Please add £25 (RRP) per cut out required

**Desk Depths:** 1600mm

**Desk Widths:** 2000, 2400, 2800, 3200, 3600mm

Dimensions			Goalpost Leg - GPL	A Frame Leg - AFR	RRP (by finish)	
W	D	H			Aztec	Unlimited
2000	1600	730	SYN2016MTGPL	SYN2016MTAFR	£850.00	£1,200.00
2400	1600	730	SYN2416MTGPL	SYN2416MTAFR	£900.00	£1,300.00
2800	1600	730	SYN2816MTGPL	SYN2816MTAFR	£950.00	£1,400.00
3200	1600	730	SYN3216MTGPL	SYN3216MTAFR	£1,000.00	£1,500.00
3600	1600	730	SYN3616MTGPL	SYN3616MTAFR	£1,100.00	£1,900.00

# Sierra One Tables



Stocked finishes:

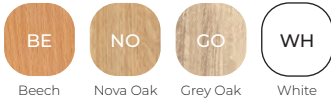

Made to order finishes:



## Rectangular

Code	Dimensions	RRP
* OFPMT1280	W1200 D800 H730	£363.00
OFPMT1480	W1400 D800 H730	£379.00
OFPMT1680	W1600 D800 H730	£394.00
OFPMT1880	W1800 D800 H730	£411.00
* OFPMTDEND1680	W1600 D800 H730	£399.00

## Circular

Code	Dimensions	RRP
OFPcMT10D	W1000 D1000 H730	£412.00
OFPcMT12D	W1200 D1200 H730	£449.00

\* All finishes made to order



## Boardroom Table 1800

Code	Dimensions	RRP
* OFPBD1800	W1800 D1200 H730	£481.00

\* All finishes made to order

## Boardroom Table 2400

Code	Dimensions	RRP
* OFPBD2400	W2400 D1200 H730	£605.00

\* All finishes made to order

# Guarda Boardroom Tables



Stocked finishes:

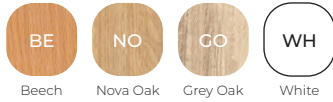

Made to order finishes:



**Round Meeting Table**

Code	Dimensions	RRP
TES1100D	W1100 D1100 H730	£320.00



**D-End Meeting Table**

Code	Dimensions	RRP
TK1810DE	W1800 D1000 H730	£367.00
TK2412DE	W2400 D1200 H730	£605.00



**Like these chairs?**  
Sosa chair (CH2249) can be found on page 56

# Reception Desking

// 03

Nothing says 'welcome' like an inviting reception area! No matter your space limitations, our reception desking lets you create the perfect introduction to your business.





## In this section



**Modular Reception Units**

page 217



**Modular Reception Tops**

page 217



**Reception Unit**

page 219



**Reception Unit  
with Extension**

page 219

## Reception mix and match

The reception desk has the option to pick the finish of the tops and sides separately, enabling you to mix finishes and create a reception unit that fits in with your office decor.

When ordering, select the finish for **Box A** to choose the desk and reception tops and select the finish for **Box B** to choose the front and side panel finish.

**Box A**



**Box B**

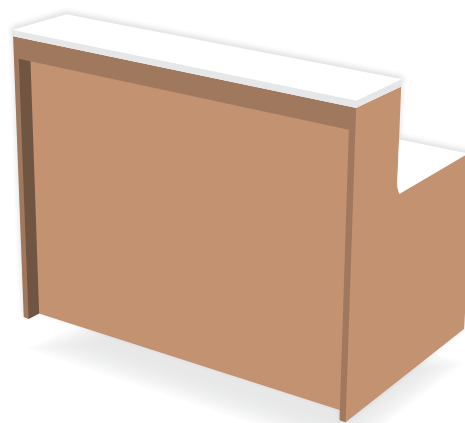



DELL

# Modular Reception



Stocked finish | Made to order finishes:



- Combine base units and optional counter tops to create your ideal solution
- 25mm top thickness
- Reception units are offered in 6 wood finishes to complement your office
- Beech, Nova Oak, Grey Oak, Dark Walnut and Maple are made to order - contact our sales team for lead time
- White finish features white cable port, made to order finishes feature black cable port



## Straight Units

Code	Dimensions	RRP
RCM800SBU	W800 D800 H742	£321.00
RCM1200SBU	W1200 D800 H742	£383.00



## Corner Unit

Code	Dimensions	RRP
RCMCB	W800 D800 H742	£383.00



## Straight Tops

Code	Dimensions	RRP
RCM800SHU	W800 D320 H400	£284.00
RCM1200SHU	W1200 D300 H400	£333.00



## Corner Top

Code	Dimensions	RRP
RCMCH	W800 D320 H400	£284.00

WELCOME





# Reception

Stocked finish | Made to order top and side finishes:



- A self-contained reception unit with a high shelf and private desk with cable ports
- Extension unit available for extra space or to allow access for wheelchair users
- Dark Walnut and Maple are made to order – contact our sales team for lead time
- Reception desks are not compatible with modular reception units, heights will not match



## Reception Unit

Code	Dimensions	RRP
RCA1400	W1462 D892 H730 / 1165	£584.00
RCA1600	W1662 D892 H730 / 1165	£648.00

Extension leg finish:



Silver



## Reception Unit with Extensions

Code	Dimensions	RRP
RCA1400EX	W2400 D890 H730 / 1165	£752.00
RCA1600EX	W2600 D890 H730 / 1165	£820.00

# Coffee Tables

// 03

Complete your space with our collection of coffee tables. Ideal for casual meetings, relaxation, or breakout areas, these tables add style to any setting.



**Like this chair?**  
Settle armchair (OF0714)  
in Grey on page 77



**Repose Side Table**  
page 222



**Contract Tables**  
page 222



**Platter Coffee Tables**  
page 223



**Tripod Coffee Table**  
page 224



**Astral Low**  
page 224



**Reception Coffee Tables**  
page 224



**Glacier Table**  
page 224



**Sync Nested Table**  
page 225

# Repose Side Table



Finish:



Black

- Sleek and modern design featuring a powder-coated matt finish
- Side coffee table equipped with a convenient storage rack
- Ideal for cafés, breakout areas, and social spaces, suitable for both indoor and outdoor use
- Crafted from durable industrial sheet steel with a tubular frame



## CH6081 // Repose

Overall	D360 W310 H460
FR	Low
Material	Steel
RRP	£95.00

# Contract Tables



Stocked top finishes | Stocked frame finishes:



Made to order top finishes:

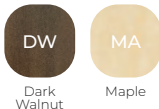

## Low Tables

Code	Dimensions	RRP
CH2683	W600 D600 H430	£342.00
CH2693	W800 D800 H430	£365.00

## Medium Tables

Code	Dimensions	RRP
CH2684	W600 D600 H725	£350.00
CH2694	W800 D800 H725	£374.00

## High Tables

Code	Dimensions	RRP
CH2685	W600 D600 H1105	£508.00
CH2695	W800 D800 H1105	£531.00

E&OE. All items are subject to VAT, where applicable.



# Platter Coffee Tables



Finish:



Black



- Modern, minimalist design with a durable steel tubular frame with a powder-coated finish
- Ideal for café settings, breakout areas, and hospitality spaces
- Versatile and adaptable to various environments
- 18mm melamine-faced chipboard (MFC) top for durability



<b>CH2782 // Platter Large Table</b>	
Overall	D800 W800 H435
FR	Low
Material	Steel / MFC
RRP	£269.00

<b>CH2781 // Platter Medium Table</b>	
Overall	D600 W600 H308
FR	Low
Material	Steel / MFC
RRP	£215.00

<b>CH2780 // Platter Small Table</b>	
Overall	D400 W400 H635
FR	Low
Material	Steel / MFC
RRP	£195.00



**Like this chair?**  
Pocket (OF0713) in pink and grey can be found on page 77

# Tripod Coffee Table

Finish:



White



Code	Dimensions	RRP
CH2670	W500 D500 H400	£203.00
CH2671	W500 D500 H440	£212.00
CH2672	W750 D750 H520	£302.00

# Astral Low

Top finishes | Frame finish:



Beech



Walnut



White



Chrome



Code	Dimensions	RRP
CH2677	W600 D600 H425	£289.00

# Reception Table

Finish:



Beech



Code	Dimensions	RRP
OF0303	Square W650 D650 H425	£215.00
OF0302	Rectangular W1050 D650 H425	£263.00

# Glacier Table

Fabric finishes:



Charcoal



Royal Blue



Code	Dimensions	RRP
OF0603	W620 D620 H370	£234.00

# Sync Nested Table

Finish:

BK

Black

- Sleek, modern design featuring a stylish matt black finish
- Tables nest perfectly for convenient storage and space-saving
- Crafted from durable industrial sheet steel with a tubular frame
- Ideal for breakout areas, cafés, dining spaces, and hospitality environments



## CH6080 // Sync

Overall	D450 W450 H460
FR	Low
Material	Steel
RRP	£115.00



**Like this soft seating?**  
Curve armchair and sofa  
can be found on page 83

# Booths & Pods

// 04

Transform your space with our collection of booths. Designed for comfort and collaboration, these versatile booths create inviting areas for meetings, brainstorming, or focused work.



**Like this chair?**

Arc 4 Leg with Brace (TA2)  
in steel blue on page 289

E&OE. All items are subject to VAT, where applicable.

## Lodge



**Workbooth**  
page 228



**Meeting Booth**  
page 228



**Phonebooth**  
page 229



**Double Booth**  
page 229

## Kuddle



**Glass Retreat**  
page 231



**Open Retreat**  
page 232



**Retreat**  
page 233



**Cove Desk**  
page 234



**Phonebooth**  
page 235



**Low Den**  
page 236



**High Den**  
page 237



**Low Round Den**  
page 238



**High Round Den**  
page 239



**Armchair with Tablet**  
page 240



**High Seating**  
page 241



Designed to seamlessly integrate into any environment



### Workbooth

LODGEWB // Workbooth

Overall W150 D99 H225



### Meeting Booth

LODGE MB // Meeting Booth

Overall W196 D128 H225

E&OE. All items are subject to VAT, where applicable.

# Lodge Booths



Finishes:



Black with Black slats



Black with Oak slats



White with Oak slats

- Provides a calm space where users can work or relax without distractions
- Stylish and modern Scandinavian-style design
- A distraction-free zone with a sound reduction level of 30dB
- Innovatively designed with easy glide wheels and tool-free assembly
- Features biophilic design elements including wooden slats, natural materials, and warm lighting



## Phonebooth

LODGEPB // Phonebooth

Overall W100 D99 H225



## Double Booth

LODGEDB // Double Booth

Overall W196 D99 H225



Contact us for more information







# Kuddle Glass Retreat

Finish:



Unlimited

The Glass Retreat has been designed with comfort and privacy in mind, offering users a space to meet, create and collaborate away from the hustle and bustle of busy working, learning and social spaces.



## 2 Seat Glass Retreat

### FK2SGD // 2 Seat Glass Retreat

Overall	D770 W2010 H2150
Seat	H450
FR	Subject to fabric selected
Fabric	100% Man-made
RRP	£25,242.00



## 4 Seat Glass Retreat

### FK4SGD // 4 Seat Glass Retreat

Overall	D1270 W2010 H2150
Seat	H450
FR	Subject to fabric selected
Fabric	100% Man-made
RRP	£28,320.00

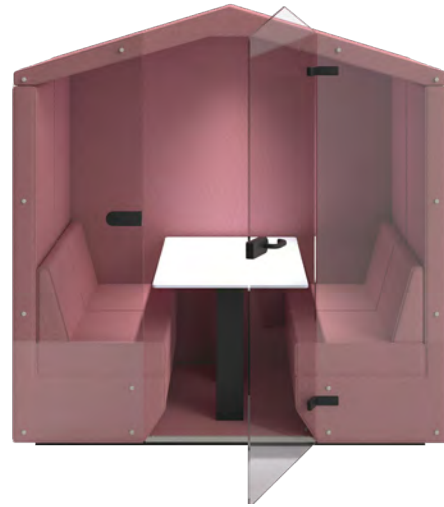

## 6 Seat Glass Retreat

### FK6SGD // 6 Seat Glass Retreat

Overall	D1870 W2010 H2150
Seat	H450
FR	Subject to fabric selected
Fabric	100% Man-made
RRP	£29,943.00



**Important note:** The weight tolerance refers to the weight tolerance per seat/bench



# Kuddle Open Retreat

Finish:



Unlimited

Our Open Retreats offer a collaborative space for its users, with a slanted roof and optional integrated power supply that has been designed specifically to improve acoustics for users looking to hot desk or work quietly.



## FK2SOPR // 2 Seat Open Retreat

Overall D840 W2340 H1980  
 Seat H450  
 FR Subject to fabric selected  
 Fabric 100% Man-made  
 RRP **£7,623.00**

## FK4SOPR // 4 Seat Open Retreat

Overall D1540 W2340 H1980  
 Seat H450  
 FR Subject to fabric selected  
 Fabric 100% Man-made  
 RRP **£9,661.00**

## FK6SOPR // 6 Seat Open Retreat

Overall D2240 W2340 H1980  
 Seat H450  
 FR Subject to fabric selected  
 Fabric 100% Man-made  
 RRP **£11,223.00**

**Important note:** The weight tolerance refers to the weight tolerance per seat/bench

E&OE. All items are subject to VAT, where applicable.

# Kuddle Retreat

Finish:



Unlimited

Our Retreats offer a collaborative space for its users, with space for 2, 4 & 6 people and a slanted roof that has been designed to add privacy for meetings, presentations and phone calls.



FK2SCLR // 2 Seat Retreat	
Overall	D940 W2340 H1980
Seat	H450
FR	Subject to fabric selected
Fabric	100% Man-made
RRP	£8,861.00

FK4SCLR // 4 Seat Retreat	
Overall	D1640 W2340 H1980
Seat	H450
FR	Subject to fabric selected
Fabric	100% Man-made
RRP	£10,560.00

FK6SCLR // 6 Seat Retreat	
Overall	D2340 W2340 H1980
Seat	H450
FR	Subject to fabric selected
Fabric	100% Man-made
RRP	£12,122.00





# Kuddle Cove Desk

Finish:



Unlimited

Our desks have been designed specifically to target busy and loud working environments, creating spaces for private working and hot desking.



A



B

	Code	Dimensions	Perch / Seat Height	RRP
A	FK1200 // 1200 Cove Desk	W800 D1200 H1400	720	£1,482.00
B	FK1400 // 1400 Cove Desk	W800 D1400 H1400	720	£1,543.00

E&OE. All items are subject to VAT, where applicable.

# Kuddle Phonebooth



Finish:



Unlimited

The Kuddle Phonebooth range has been specifically designed to offer its users maximum comfort, focus and privacy, available in a variety of styles to fit your spaces needs and requirements.

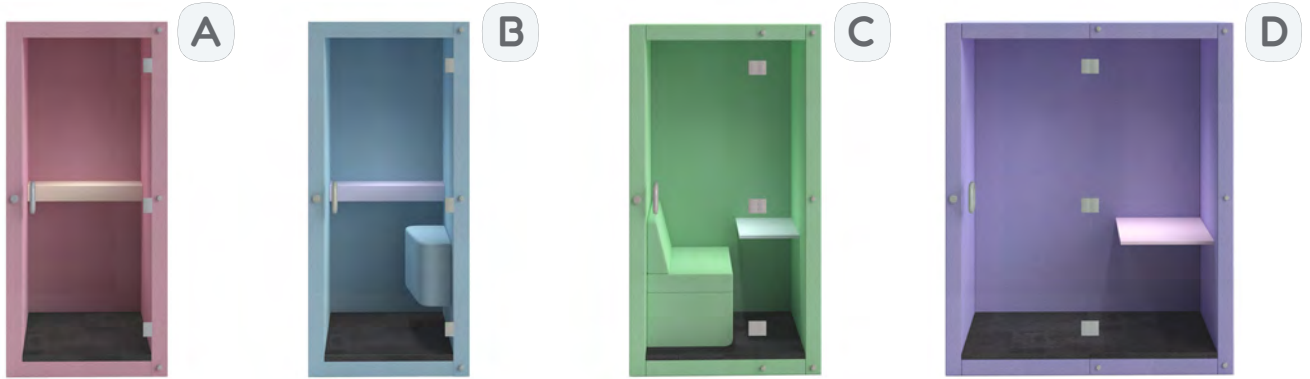

	Code	Dimensions	Perch / Seat Height	RRP
A	FKSPB // Standing Phonebooth	W1000 D1000 H2200	N/A	£11,223.00
B	FKPBP // Perch Phonebooth	W1000 D1000 H2200	H730	£11,722.00
C	FKPB12W // 1200 Phonebooth	W1200 D1000 H2200	H430	£15,882.00
D	FKPB18W // 1800 Phonebooth	W1800 D1000 H2200	N/A	£17,520.00





# Kuddle Low Den

Finish:



Unlimited

Our Low Dens have been designed with collaboration in mind, creating a space to work together away from the hustle and bustle of the workplace, without compromising on practicality or functionality.



## FK2SLDEN // 2 Seat Low Den

Overall D750 W2400 H800  
 Seat H450  
 FR Subject to fabric selected  
 Fabric 100% Man-made  
 RRP **£4,263.00**

## FK4SLDEN // 4 Seat Low Den

Overall D1350 W2400 H800  
 Seat H450  
 FR Subject to fabric selected  
 Fabric 100% Man-made  
 RRP **£5,741.00**

## FK6SLDEN // 6 Seat Low Den

Overall D1900 W2400 H800  
 Seat H450  
 FR Subject to fabric selected  
 Fabric 100% Man-made  
 RRP **£6,960.00**

**Important note:** The weight tolerance refers to the weight tolerance per seat/bench

E&OE. All items are subject to VAT, where applicable.

# Kuddle High Den

Finish:



Unlimited

Our High Dens have been specifically designed to offer space for private and project work with central tables, optional integrated power supply and 2, 4 & 6 person configurations.



## FK2SHDEN // 2 Seat High Den

Overall	D750 W2400 H1300
Seat	H450
FR	Subject to fabric selected
Fabric	100% Man-made
RRP	£6,183.00

## FK4SHDEN // 4 Seat High Den

Overall	D1350 W2400 H1300
Seat	H450
FR	Subject to fabric selected
Fabric	100% Man-made
RRP	£7,562.00

## FK6SHDEN // 6 Seat High Den

Overall	D1900 W2400 H1300
Seat	H450
FR	Subject to fabric selected
Fabric	100% Man-made
RRP	£8,903.00





## Kuddle Low Round Den

Finish:



Unlimited

Tailored for collaborative discussions and socialising away from the daily hustle, our Low Round Den provides a designated space for users to gather, work, or simply unwind.

Crafted with curved units, these dens prioritise user comfort and seclusion, forming ideal zones for both group projects and focused individual work.



### FKMSL // Round Low Den

Overall	D2500 W2500 H800
Seat	H450
FR	Subject to fabric selected
Fabric	100% Man-made
<b>RRP</b>	<b>£11,600.00</b>



# Kuddle High Round Den



Finish:



Unlimited

Our High Round Den presents an alternative to conventional meeting areas and boardrooms, offering a comfortable and private setting for meetings and one-on-one interactions with its soft fabric selections and elevated backrest.



<b>FKMSH // Round High Den</b>	
Overall	D2500 W2500 H1400
Seat	H450
FR	Subject to fabric selected
Fabric	100% Man-made
<b>RRP</b>	<b>£12,762.00</b>





## Kuddle Armchair with Tablet



Finish:



Unlimited

Crafted with precision, the Kuddle Armchair with Tablet is meticulously designed to provide users with unparalleled comfort, concentration, and privacy, all while fostering collaboration.



### FKHAT // Armchair with Tablet

Overall	D1200 W800 H1400
Seat	H450
FR	Subject to fabric selected
Fabric	100% Man-made
RRP	£2,134.00

**Important note:** The weight tolerance refers to the weight tolerance per seat/bench

E&OE. All items are subject to VAT, where applicable.

# Kuddle High Seating

Finish:



Unlimited

Our High Seating provides a conducive space for collaboration, productivity, and socialisation. The distinguishing feature of the high backrest adds an extra layer of privacy to the design.



## FK1SH // High Armchair

Overall	D750 W750 H1300
Seat	H450
FR	Subject to fabric selected
Fabric	100% Man-made
RRP	£2,400.00

## FK2SH // 2 Seat High Sofa

Overall	D750 W1350 H1300
Seat	H450
FR	Subject to fabric selected
Fabric	100% Man-made
RRP	£3,063.00

## FK3SH // 3 Seat High Sofa

Overall	D750 W1900 H1300
Seat	H450
FR	Subject to fabric selected
Fabric	100% Man-made
RRP	£3,722.00





# Bubble

Welcome to Bubble – where productivity and privacy meet in a symphony of style and innovation! We believe Bubble is more than a pod – it’s a sanctuary, that enables you to access a whole new way of focusing, meeting, and collaborating, whether you’re in a busy office, or a vibrant public environment.

Want to work in an environment free from distractions? Bubble’s advanced soundproofing will cocoon you in silence. We’ve designed Bubble to achieve a sound reduction up to 46 dB! Unbeatable sound reduction keeps your conversations private and external noise out.

This exceptional soundproofing is made possible through several patented technical innovations including our double-panel sliding door and thick glass panels.

Our innovative ventilation system automatically balances CO<sub>2</sub> levels, ensuring optimal air quality to maintain productivity. Packed with state-of-the-art air filters, 99.9% of impurities and harmful particles are removed, ensuring you’re breathing pollution-free air, and dramatically reducing the risk of respiratory infections.



Contact us for  
more information

# Talos Steel Storage

// 05

Looking for storage that stands the test of time? The Talos collection is the perfect storage solution, meaning you can keep your workspace tidy and your essentials easily accessible.



**Like this chair?**

Sosa chair (CH2249) in black  
on page 56



**Talos Steel Pedestals**  
page 246

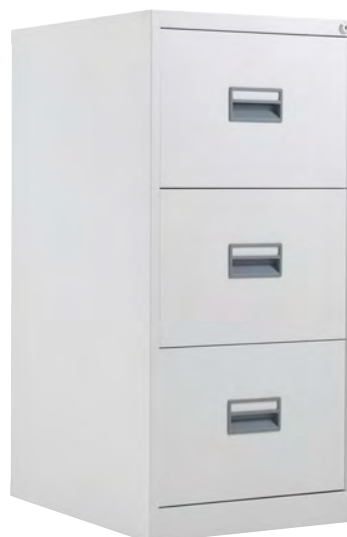

**Talos Filing Cabinets**  
page 247



**Talos Tambours**  
page 248



**Talos Cupboards**  
page 249

# Talos Steel Pedestals



Stocked finishes:



White



Black



Silver



## Mobile Pedestal

- Pen tray included with this model
- Fits A4 files side to side and front to back with filing bar
- Fits foolscap front to back
- Anti-tilt

### TKUSMP3 // Mobile Pedestal

Overall D470 W380 H615

RRP £357.00

Stocked finishes:



White



Black



Silver



## Slimline Mobile Pedestal

- Pen tray not available with the slimline model
- Fits A4 front to back with filing bar
- Fits foolscap front to back with filing bar
- Anti-tilt

### TKUSSMP3 // Slimline Mobile Pedestal

Overall D470 W300 H615

RRP £335.00



# Talos Filing Cabinets

Stocked finishes:

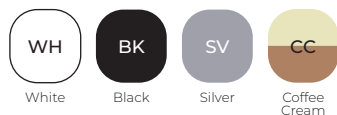

- 100% drawer extension
- Anti-tilt
- Fits A4 side to side with filing bar
- Fits foolscap side to side

Code	Drawers	Dimensions	RRP
TCS2FC	2	W465 D620 H695	£361.00
TCS3FC	3	W465 D620 H1000	£388.00
TCS4FC	4	W465 D620 H1300	£472.00



**Products featured:**  
Talos 4 drawer filing cabinets in silver, coffee & cream, white and black

# Talos Tambours



Stocked finishes:



White



Black



Silver



- A flexible alternative to wooden storage
- Lockable side-opening shutter door
- Allows users to mix flat shelves and suspension frames together
- Included shelves can be used for under shelf filing
- TCSOTFF fits A4 front to back or side to side
- Shelves can only hold one row of foolscap files
- The tambour filing frame and additional shelves can be purchased separately

Code	Shelves	Dimensions	RRP
TCSOT1050	2	W1000 D450 H1050	£752.00
TCSOT1950	4	W1000 D450 H1950	£963.00
TCSOTFF	Roll out tambour filing frame		£218.00
TCS-TAM-SHELF	Dual purpose tambour shelf (black)		£74.00



**Products featured:**  
Talos tambours in grey, 2 and 4 shelves

# Talos Cupboards



Stocked finishes:



- A flexible alternative to wooden storage
- Square lockable handles
- Included shelves can be used for under shelf filing
- 180° door opening

Code	Shelves	Dimensions	RRP
TCSDDC1000	2	W920 D420 H1000	£398.00
TCSDDC1790	4	W920 D420 H1790	£512.00
TCSDDC1950	4	W920 D420 H1950	£640.00
TCS-SHELF-BK	Dual purpose cupboard shelf		£41.00



**Products featured:**  
Talos cupboards in white, 2 and 4 (1790mm) shelves

# Bisley

// 05

Discover the Bisley collection. This British-made range features a variety of durable steel products designed for flexible storage. Whether you need solutions for the office or home, Bisley has you covered.





**Classic Filing**  
page 252



**Contract Filing**  
page 252



**Personal Filing**  
page 253



**A4 Home Filing**  
page 253



**MultiDrawers**  
pages 254-255



**Steel Planter**  
page 256



**Essentials Side Filers**  
page 257



**Essentials Tambours**  
page 257



**Cupboards**  
page 258



**Lower Height Lockers**  
page 259



**Lockers**  
page 260



**Primary Lockers**  
page 261



**Clean & Dirty Locker**  
page 262



**Combi Locker**  
page 262



**Police Locker**  
page 263



**Cloakroom Benches**  
page 263

### Care & Maintenance

Carefully remove any loose surface deposits with a wet sponge. Use a soft brush (non abrasive) and a dilute solution of a mild detergent, eg, pH-neutral liquid hand dishwashing detergent in warm water (DO NOT use solvents) to remove dust, salt and other deposits.

# Bisley Classic Filing



Made to order finishes:



G/G

Goose Grey



BLK

Black



c/c

Coffee / Cream



CHK

Chalk



BLU

Blue



- Built to last fully welded construction
- Double skin drawer fronts
- Suitable for foolscap and A4 filing
- BS2E & BS4E stocked in black and goose grey
- Each drawer can hold up to 45kg of hanging suspension files. For use with suspension files only. Drawer bottoms are not load bearing

Code	Drawers	Dimensions	RRP
BS2E	2	W470 D622 H711	£535.00
BS3E	3	W470 D622 H1016	£620.00
BS4E	4	W470 D622 H1321	£717.00

# Bisley Contract Filing

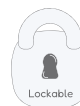

Stocked finishes:



G/G

Goose Grey



BLK

Black



c/c

Coffee / Cream



CHK

Chalk



- Manufactured to meet British Standards for strength and stability
- Fitted with recessed handles
- Drawer label holders
- Central locking
- Anti-tilt to prevent more than one drawer being opened at a time
- Each drawer can hold up to 35kg of hanging suspension files. For use with suspension files only. Drawer bottoms are not load bearing.

Code	Drawers	Dimensions	RRP
AOC2	2	W470 D622 H711	£379.00
AOC3	3	W470 D622 H1016	£452.00
AOC4	4	W470 D622 H1321	£500.00

E&OE. All items are subject to VAT, where applicable.

# Bisley Personal Filing

Made to order finishes:



- Suitable for use with A4 suspension files
- Drawer loading capacity of 15kg
- Suitable for foolscap filing
- 2 drawer supplied with 1 lock and 2 keys
- 3 and 4 drawer units supplied with 2 locks and 2 keys for each
- Moulded plastic centre pull handle
- 2 drawer and 3 drawer models available in all colours, 4 drawer only available in goose grey, black and grey/blue

Code	Drawers	Dimensions	RRP
A4PHF2D	2	W413 D400 H672	£247.00
A4PHF3D	3	W413 D400 H1015	£320.00
A4PHF4D	4	W413 D400 H1321	£439.00

# Bisley A4 Home Filing

Made to order finishes:



- Lightweight storage ideal for the home office
- Suitable for use with A4 suspension files
- Drawer loading capacity of 15kg
- 2 drawer supplied with 1 lock and 2 keys
- Single action lock secures 2 drawers (bottom 2 on 3 drawer)
- Moulded plastic centre pull handle
- 3 drawer non mobile model available in all colours with 2 and 3 drawer mobile models only available in goose grey and black

Code	Drawers	Dimensions	RRP
A4NMHF3D	3 - non mobile	W413 D400 H672	£313.00
A4MHF2D	3 - mobile	W413 D400 H525	£237.00
A4MHF3D	4 - mobile	W413 D400 H525	£252.00

# Bisley MultiDrawers



Stocked finish | Made to order finishes:



## Drawer Height - 87mm high

Code	Drawers	Dimensions	RRP
H29/6NL	6	W279 D380 H590	£305.00
H39/9NL	9	W279 D380 H860	£411.00

## Drawer Height - 51mm high

Code	Drawers	Dimensions	RRP
H29/10NL	10	W279 D380 H590	£310.00
H39/15NL	15	W279 D380 H860	£435.00



NOTE: Only available in black.

## Drawer Height - 87mm high

Code	Description	RRP
HMDPLNTH	118mm high black plinth base, single for 10 & 15 drawer	£41.00

## Compartment Trays

Code	Description	RRP
224P5/1	A4 24 compartment tray	£27.00
225P5/1	A4 16 compartment tray	£27.00
226P5/1	A4 9 compartment tray	£27.00
227P5/1	A4 4 compartment tray	£27.00



# Bisley MultiDrawers



Made to order finishes:

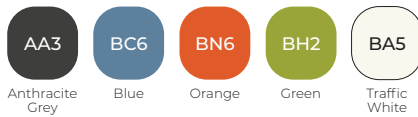

The MultiDrawer is a design classic that's as versatile as it is iconic



## 3 Drawer

Code	Dimensions	RRP
H123NL-BN6	W279 D380 H325	£160.00

## 5 Drawer

Code	Dimensions	RRP
H125NL-AA3	W279 D380 H325	£180.00



# Bisley Steel Planter



Made to order finishes:

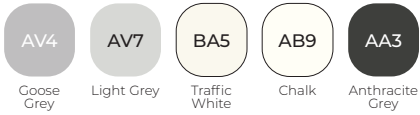

- The ideal way to add a touch of biophilic design into your environment
- Creates a healthier, more creative, and colourful workspace
- Complements 470mm deep Bisley storage units
- With a discreet watertight liner
- Available in a range of modern, muted colours

Code	Dimensions	FR	Material	RRP
RP08M	W800 D470 H113	Low	Steel & Plastic	£485.00
RP10M	W1000 D470 H113	Low	Steel & Plastic	£625.00



# Bisley Essentials Side Filers



Made to order finishes:



- Ideal for offices where floor space is limited
- Fits A4 and foolscap suspension filing
- All units have adjustable feet

Code	Drawers	Dimensions	RRP
ESSF2D	2	W800 D470 H693	£1,455.00
ESSF3D	3	W800 D470 H1000	£1,653.00
ESSF4D	4	W800 D470 H1300	£2,134.00
YETBUS08	Shelf   undershelf filing		£58.00

# Bisley Essentials Tambours



Stocked finish | Made to order finishes | Made to order shutter finishes:



- Adjustable feet
- Priced empty, for interior fittings, see page 255

Code	Dimensions	RRP
ESSOT101	W1000 D470 H1015	£802.00
ESSOT158	W1000 D470 H1585	£979.00
ESSOT198	W1000 D470 H1985	£1,031.00

Additional

Code	Description	RRP
YETBUS10	Shelf   undershelf filing	£49.00
ROSFF	Roll out suspension filing frame*	£222.00
BUS1	Shelf with adjustable undershelf filing*	£125.00
BUR	Adjustable lateral filing rail*	£60.00

\* Available in black

# Bisley Contract Cupboards

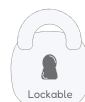

Made to order finishes:



- 3 point locking system
- Included shelves can be used for under shelf filing

Code	Shelves	Dimensions	RRP
E402A01	1	W914 D400 H1000	£445.00
E722A03	3	W914 D400 H1806	£1,653.00
E782A04	4	W914 D400 H1950	£2,134.00
E198P1/BLK - Extra dual purpose shelf, black only			£37.00

Additional

Code	Description	RRP
ROSFF	Roll out suspension filing frame*	£222.00
BUS1	Shelf with adjustable undershelf filing*	£125.00
BUR	Adjustable lateral filing rail*	£60.00

\* Available in black

# Bisley Essentials Cupboards



Made to order finishes:



- Wide range of interior fittings available
- Levelling feet
- Standard shelves can be used for under shelf filing
- Supplied empty, please choose from shelves below

Code	Dimensions	RRP
ESCB101	W914 D470 H1015	£591.00
ESCB158	W914 D470 H1585	£632.00
ESCB198	W914 D470 H1985	£831.00
YETBUS10	Standard shelf	£49.00
ROSFFBLK	Roll-out suspension filing frame	£222.00
BSSPDP1BLK	Slotted shelf	£92.00
SHDV85P5PS	Pack of 5 dividers for slotted shelf	£92.00
ROSHBLK	Roll-out shelf	£194.00

# Bisley Lower Height Lockers



Made to order carcass finish | Made to order door finishes:

<b>AV7</b>	<b>AV7</b>	<b>AY8</b>	<b>AY7</b>
Light Grey	Light Grey	Cardinal Red	Oxford Blue

- All lockers are available with up to three doors and banks of up to four columns
- All doors are available with discreet label holders



**1 Door**



**2 Door**



**3 Door**

Code	Dimensions	RRP
PLHS9125381	W225 D380 H915	£270.00
PLHS1330451	W300 D450 H1370	£353.00

Code	Dimensions	RRP
PLHS3350452	W500 D450 H1330	£473.00
PLHS1330302	W300 D300 H1370	£353.00

Code	Dimensions	RRP
PLHS3350453	W500 D450 H1330	£530.00
PLHS1330453	W300 D450 H1370	£450.00



# Bisley Lockers



Stocked finish:



Goose Grey

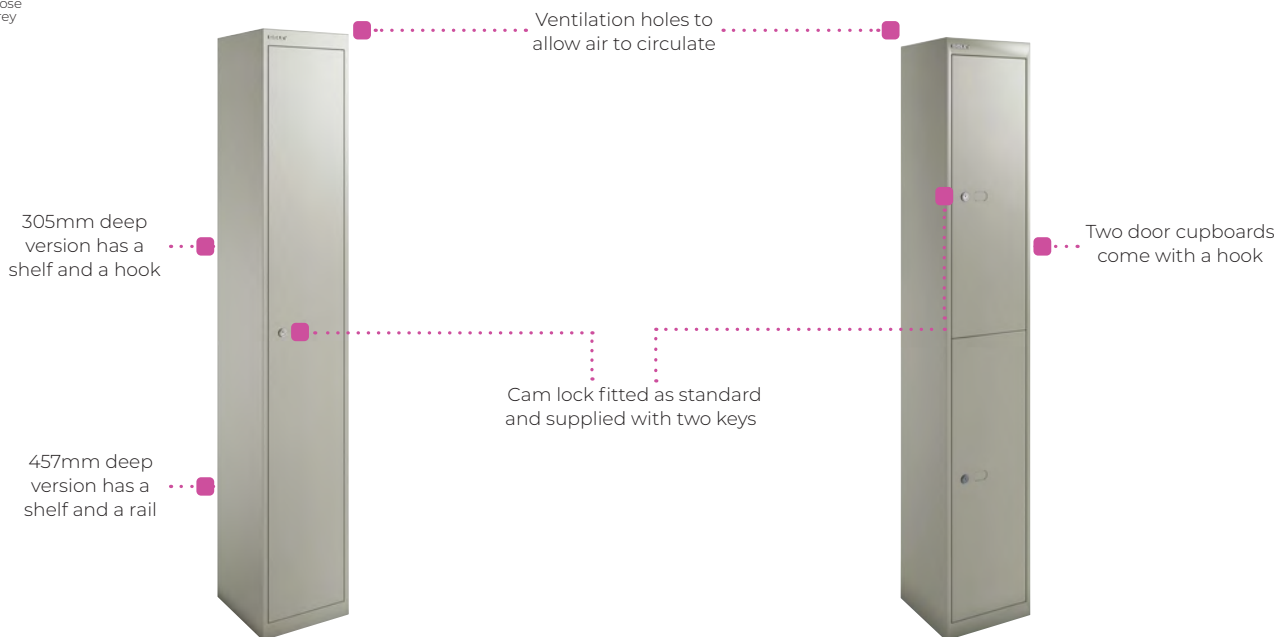

## 1 Door Locker

Code	Dimensions	RRP
CLK121	W305 D305 H1802	£270.00
CLK181	W305 D457 H1802	£320.00

## 2 Door Locker

Code	Dimensions	RRP
CLK122	W305 D305 H1802	£340.00
CLK182	W305 D457 H1802	£385.00

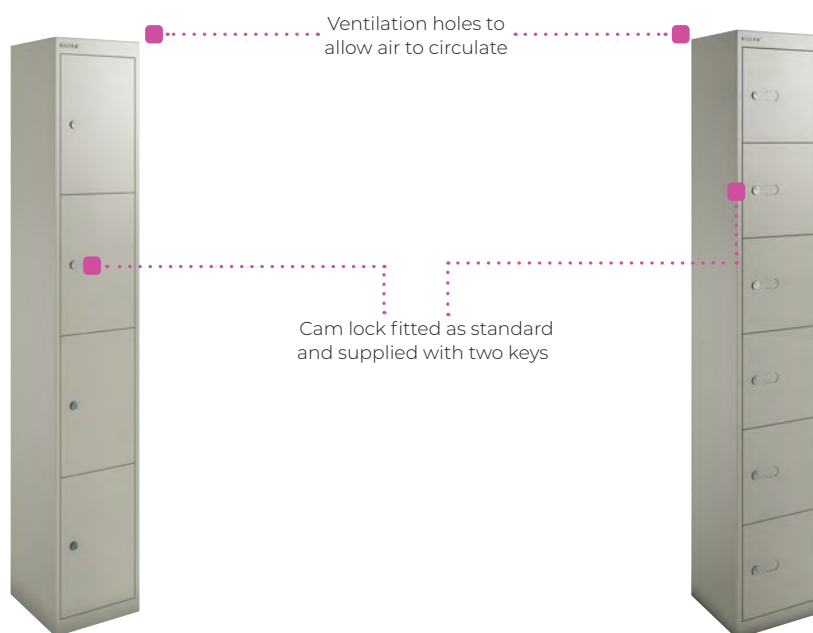

## 4 Door Locker

Code	Dimensions	RRP
CLK124	W305 D305 H1802	£405.00
CLK184	W305 D457 H1802	£445.00

## 6 Door Locker

Code	Dimensions	RRP
CLK126	W305 D305 H1802	£475.00
CLK186	W305 D457 H1802	£530.00

# Bisley Primary Lockers



Made to order finishes:



- All lockers are available with up to six doors and banks of up to four columns
- All doors are available with discreet label holders
- Compatible with steel locker stand, standard locker plinth, and raised foot with levelling capabilities.



**1 Door**

Code	Dimensions	RRP
PEDS1830451	W300 D450 H1800	£355.00



**2 Door**

Code	Dimensions	RRP
PEDS1830452	W300 D450 H1800	£398.00



**3 Door**

Code	Dimensions	RRP
PEDS1830453	W300 D450 H1800	£435.00



**4 Door**

Code	Dimensions	RRP
PEDS1830454	W300 D450 H1800	£450.00



**5 Door**

Code	Dimensions	RRP
PEDS1830455	W300 D450 H1800	£495.00



**6 Door**

Code	Dimensions	RRP
PEDS1830456	W300 D450 H1800	£535.00

# Bisley Clean and Dirty Locker



Made to order carcass finish | Made to order door finishes:



Light Grey



Light Grey



Cardinal Red



Oxford Blue

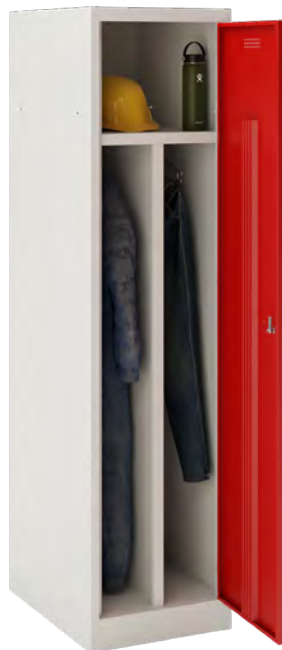

The Clean and Dirty Locker is a single door locker divided into two clothing compartments with hanging rails, perfect for separating clean clothes from dirty workwear and overalls. With shelving above, there is also space for your personal belongings to be kept clean, safe and secure.

- Designed for durability
- Features smart grey carcass and a selection of door colours

Code	Dimensions	RRP
PCDS1845601	W600 D450 H1800	£502.00

# Bisley Combi Locker



Made to order carcass finish | Made to order door finishes:



Light Grey



Light Grey



Cardinal Red



Oxford Blue



The Combi Locker features a narrow hanging space with a coat hook and a series of internal shelves above and to the side, enclosed behind a single door. There is enough space to store personal and workwear items in a range of working environments.

- Designed for durability
- Features smart grey carcass and a selection of door colours

Code	Dimensions	RRP
PCOS1845451	W450 D450 H1800	£404.00



# Bisley Police Locker

Made to order carcass finish | Made to order door finishes:



The Clean and Dirty Locker is a single door locker divided into two clothing compartments with hanging rails, perfect for separating clean clothes from dirty workwear and overalls. With shelving above, there is also space for your personal belongings to be kept clean, safe and secure.

- Designed for durability
- Features smart grey carcass and a selection of door colours

Code	Dimensions	RRP
PPOS1845601	W600 D450 H1800	£452.00





# Bisley Cloakroom Benches



Made to order frame finishes:

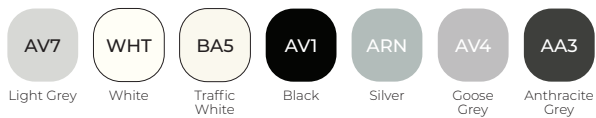

- The steel frames have a light grey coating that resists scratches
- The black bench slats are made from recycled plastic
- Overhead hooks offer flexible and robust storage for coats
- Adjustable feet allow the bench to be levelled
- Delivered assembled and ready to use



## Single Sided Cloakroom Bench

Code	Hooks	Dimensions	RRP
PCJ131230	9	W1200 D300 H1370	£1,125.00
PCJ131530	9	W1200 D300 H1800	£1,145.00
PCB181230	9	W1200 D300 H1800	£1,145.00
PCB181530	12	W1500 D600 H1800	£1,195.00

## Double Sided Cloakroom Bench

Code	Hooks	Dimensions	RRP
PCDJ131260	18	W1200 D600 H1370	£1,525.00
PCDJ131560	24	W1500 D600 H1370	£1,615.00
PCD181260	12	W1200 D600 H1800	£1,525.00
PCD181560	24	W1500 D600 H1800	£1,698.00



## Free Standing Single Bench

Code	Dimensions	RRP
PFB471030	W1000 D300 H470	£615.00
PFB471230	W1200 D300 H470	£725.00

# Lockers & Safes

// 05

Looking for a secure place to store your valuables? Our versatile selection of wooden and steel lockers, and fire-resistant safes, are designed to keep everything important safe, whether you're at work or home.





**Wooden Lockers**  
page 268



**Steel Lockers**  
page 269



**Fire Resistant Safes**  
pages 270-271



**Safes**  
page 272-273

# Wooden Lockers



Made to order finishes:



- Available in 8 finishes
- Cam locks come as standard. All other locks are POA
- 18mm wooden carcass
- Bespoke options available, please contact us for details
- Available in 6 door configurations
- Outer carcass and wooden plinth available on request



**1 Door Locker**

Code	Doors	Dimensions	RRP
TCCP1	1	W350 D400 H1900	£995.00



**2 Door Locker**

Code	Doors	Dimensions	RRP
TCCP2	2	W350 D400 H1900	£1,195.00



**3 Door Locker**

Code	Doors	Dimensions	RRP
TCCP3	3	W350 D400 H1900	£1,395.00



**4 Door Locker**

Code	Doors	Dimensions	RRP
TCCP4	4	W350 D400 H1900	£1,595.00



**5 Door Locker**

Code	Doors	Dimensions	RRP
TCCP5	5	W350 D400 H1900	£1,795.00



**6 Door Locker**

Code	Doors	Dimensions	RRP
TCCP6	6	W350 D400 H1900	£1,995.00

# Steel Lockers



Made to order finishes:



- Available in 6 door finishes
- Biocote paint finish provides an antibacterial surface
- Single door lockers come with coat hook and hat shelf
- Ventilated top and bottom to allow for air circulation
- Meets BS4680-1996 specification for clothes lockers



## 1 Door Locker

Code	Doors	Dimensions	RRP
TC1DRLK30	1	W300 D300 H1800	£334.00
TC1DRLK45	1	W300 D450 H1800	£381.00



## 2 Door Locker

Code	Doors	Dimensions	RRP
TC2DRLK30	2	W300 D300 H1800	£358.00
TC2DRLK45	2	W300 D450 H1800	£410.00



## 4 Door Locker

Code	Doors	Dimensions	RRP
TC4DRLK30	4	W300 D300 H1800	£451.00
TC4DRLK45	4	W300 D450 H1800	£493.00



## 6 Door Locker

Code	Doors	Dimensions	RRP
TC6DRLK30	6	W300 D300 H1800	£537.00
TC6DRLK45	6	W300 D450 H1800	£584.00

# Fire Resistant Safes

Finishes:



FS2254E  
Electronic lock

FS2252K  
Key lock

FSDPI08  
Key lock

## World Class Vertical Fire File

FS2250K/E Series

Code	Drawers	Weight (kg)	Dimensions	RRP
FS2252K	2	140	W140 D675 H720	£3,069.00
FS2252E	2	140	W140 D675 H720	£3,140.00
FS2254K	4	266	W525 D675 H1405	£4,447.00
FS2254E	4	266	W525 D675 H1405	£4,517.00
FSDPI08	20		Data protection insert	£917.00



Electronic Locking (E), Key Locking (K). 90 Minutes fire protection for paper records & data when FSDPI08 is used. Water resistant seals prevent damage to contents against sprinkler systems. Able to accommodate Foolscap, A4 & A5 files using width adjustable rails. Independent drawer locking allows any combinations of open or locked drawers.



FS1912E  
Electronic lock

FS1913E  
Electronic lock

FS1914E  
Electronic lock

## Fire Commander

FS1910E Series

Code	Litres	Weight (kg)	Dimensions	RRP
FS1911E	220	260	W690 D650 H1160	£4,726.00
FS1912E	338	340	W690 D650 H1685	£6,916.00
FS1913E	332	358	W950 D650 H1160	£8,475.00
FS1914E	626	554	W1125 D650 H1685	£9,137.00



Electronic Locking (E), Key Locking (K). 90 Minutes fire protection for paper records & data when FSDPI08 is used. Water resistant seals prevent damage to contents against sprinkler systems. Able to accommodate Foolscap, A4 & A5 files using width adjustable rails. Independent drawer locking allows any combinations of open or locked drawers.





### Fire Ranger

#### FS1510K/E Series

Code	Litres	Weight (kg)	Dimensions	RRP
FS1511K	230	77	W600 D520 H1225	£2,464.00
FS1511E	230	77	W600 D520 H1225	£3,033.00
FS1512K	359	106	W930 D520 H1225	£3,147.00
FS1512E	359	106	W930 D520 H1225	£3,905.00
FS1513K	615	152	W930 D520 H1950	£4,038.00
FS1513E	615	152	W930 D520 H1950	£4,901.00
FS1514K	851	194	W1255 D520 H1950	£5,136.00
FS1514E	851	194	W1255 D520 H1950	£6,066.00



Electronic Locking (E), Key Locking (K). 30 Minutes fire protection for paper records. High security VDS Class 1 key lock or electronic locking with LED display. Recommended for £1,500 overnight cash cover or £15,000 for valuables. Height adjustable shelves that also include hanging rails for lateral files.

### Data Protection

Code	Description	RRP
FSDPI03	Insert for FS1510K/E Series (except FS1511K/E) & FS1910E Series	£802.00



### Key



# Safes



KS0031E  
Electronic lock

KS0032E  
Electronic lock

KS0033E  
Electronic lock

## Electronic Key Safes

### FS0030E Series

Code	Hooks	Weight (kg)	Dimensions	RRP
KS0031E	30	6.5	W140 D675 H720	£251.00
KS0032E	48	7.5	W140 D675 H720	£280.00
KS0033E	144	20	W525 D675 H1405	£479.00



High quality electronic locking with override key lock (2 keys supplied). Suitable for 30, 48 & 144 keys. Coloured key rings & tags supplied. Key deposit slot allows keys to be deposited without opening the safe. Ready prepared for floor or wall fixing (bolts supplied).

Finish:



White

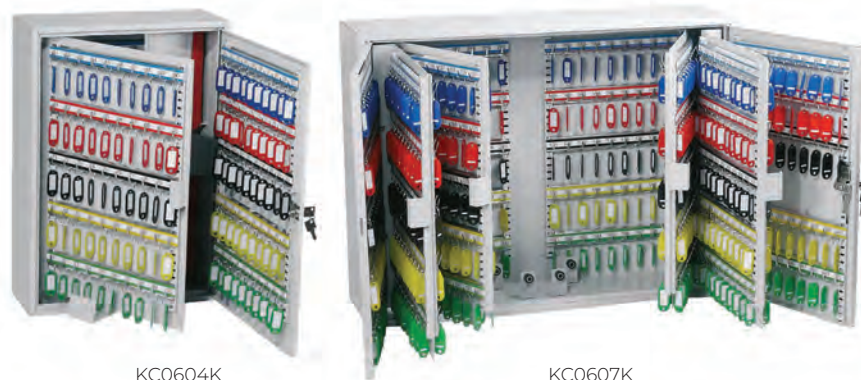

KC0604K

KC0607K

## Commercial Key Cabinets

### KC0600 Series

Code	Litres	Weight (kg)	Dimensions	RRP
KC0601K	42	4	W270 D80 H350	£179.00
KC0602K	64	6	W300 D80 H450	£222.00
KC0603K	100	7	W380 D80 H550	£295.00
KC0604K	200	11	W380 D140 H550	£395.00
KC0605K	300	14	W380 D205 H550	£565.00
KC0606K	400	20	W730 D140 H550	£828.00
KC0607K	600	28	W730 D205 H550	£1,084.00

Finish:



White

Cabinets are manufactured with a high quality cylinder key lock supplied with 2 keys. Each unit comes with adjustable hook bars and number labels with pre-drilled fixing holes for wall mounting. Finished in a high quality durable powder coated finish.



SS0805E  
Electronic lock



SS0804E  
Electronic lock



SS0803E  
Electronic lock



SS0802E  
Electronic lock



SS0801E  
Electronic lock

## Compact Home / Office

### SS0800E Series

Code	Litres	Weight (kg)	Dimensions	RRP
SS0801E	10	6	W310 D200 H200	£201.00
SS0802E	17	8	W350 D250 H250	£247.00
SS0803E	34	12	W450 D365 H250	£372.00
SS0804E	51	19	W350 D310 H500	£436.00
SS0805E	88	23	W370 D445 H560	£557.00



Recommended for £1,000 overnight cash cover or £10,000 for valuables. Advanced user friendly electronic locking with high security anti-tamper or bounce solenoid locking system. Ready prepared for fixing to the floor or wall. Ready prepared for floor or wall fixing (bolts supplied). Fitted with bright internal LED light.

Finish:



Anthracite



SS1181K  
Key lock



SS1182E  
Electronic lock



SS1183K  
Key lock

## Fortress

### SS1180K/E Series

Code	Litres	Weight (kg)	Dimensions	RRP
SS1181K	7	15	W350 D300 H220	£630.00
SS1181E	7	15	W350 D300 H220	£873.00
SS1182K	24	25	W450 D350 H350	£831.00
SS1182E	24	25	W450 D350 H350	£1,020.00
SS1183K	42	37	W450 D350 H550	£1,196.00
SS1183E	42	37	W450 D350 H550	£1,478.00



60 minutes fire protection for paper records & digital media, DVD's & USB sticks. Recommended for £2,000 overnight cash cover or £20,000 for valuables. High security electronic lock. Drop tested from 9.1 meters & suitable for base fixing (bolts supplied).

Finish:



White

## Key



# Media Units

// 05

Ready to enhance your workspace? Our office media units blend style and functionality, providing a sleek solution for organising technology and media equipment.



**Like this chair?**  
Faze chair (OF0604)  
found on page 54



**Media Units**  
pages 276-277



**Media Walls**  
pages 278-279



Ma  
Why +  
T  
y of Cont  
HTML  
TML  
TML  
Markdown!  
Plain Text  
converts  
To Anything  
To  
Process  
Any text ed  
Atom.io  
Atom.io, D  
Markdown

# Media Units



Made to order colour finishes | Made to order wood grain finishes:

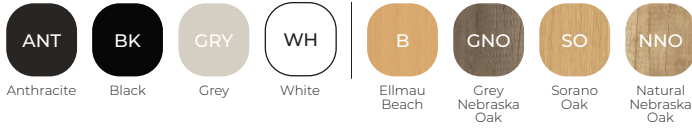

- Cam locks come as standard. All other locks are POA
- 18mm wooden carcass
- Bespoke options available, please contact our sales team for more information



## Media Cupboard

TTWMOD1 // Media Cupboard	
Overall	D600 W1018 H2000
Material	MFC
FR	Low



## Sliding Door Media Unit

TTWMOD3 // Sliding Door Media Unit	
Overall	D1018 W600 H2100
Material	MFC
FR	Low



## Shelving Unit with Desk

TTWMOD5 // Shelving Unit with Desk	
Overall	D600 W1018 H2000
Material	MFC
FR	Low



## Screen and Storage Unit

TTWMOD2 // Screen and Storage Unit	
Overall	D600 W2000 H2100
Material	MFC
FR	Low



## Media Tray Wall

TTWMOD4 // Media Tray Wall	
Overall	D600 W2000 H2100
Material	MFC
FR	Low

# Media Walls

Made to order colour finishes | MTO wood grain finishes:



- Designed to create stylish, adaptable, and contemporary storage and organisation solutions
- Available in eight distinct finishes
- Five module configurations to choose from



## Classic Media Wall

TTWBUN01 // Classic Media Wall

Overall	D600 W4036 H2100
Material	MFC
FR	Low



## Sliding Door Media Wall

TTWBUN02 // Sliding Door Media Wall

Overall	D600 W4036 H2100
Material	MFC
FR	Low





### Complete Media Wall

TTWBUN03 // Complete Media Wall

Overall	D600 W4036 H2100
Material	MFC
FR	Low



### Open Media Wall

TTWBUN04 // Open Media Wall

Overall	D600 W4036 H2100
Material	MFC
FR	Low

# Power, Accessories & Coat Stands

// 06

Our range of office power solutions and accessories is designed with flexibility in mind! These essentials help you manage your space whilst catering to your personal needs.





**On Desk Power Modules**  
page 282



**In Desk Power Modules**  
page 283



**Round In Desk Power Modules**  
page 283



**Desk Accessories**  
page 284



**Coat Stands**  
page 285



## On Desk Power Modules



Finishes:

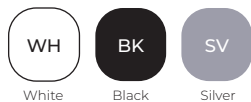

- Aluminium housing and decorative veneer available in white, silver or black to suit your aesthetic
- Different colour combinations are available
- 70% faster charging with True Fast Charge
- Single or double 240V power socket
- 100W USB-C Synapse™ smart functionality available (requires additional hub), 30W USB-C and 27W USB-A as standard
- 0.5m cable with GST connector
- Exceeds BS1363-2, BS5733 (1,2 & 3) and ASTA Approved
- Designed to go beyond the requirement of BS6396:2022, and consequently are the safest products on the market
- **Supplied with 3m mains lead**

White/White	Black/Black	Silver/Grey	Description	RRP
NEXBUN001WH	NEXBUN001BK	NEXBUN001GR	Single socket, 1 x 30W USB-C, 1 x 27W USB-A	£138.00
NEXBUN002WH	NEXBUN002BK	NEXBUN002GR	Double socket	£82.00
NEXBUN003WH	NEXBUN003BK	NEXBUN003GR	Single socket, 1 x USB-C 100W Synapse power & data, 1 x 27W USB-A (*hub required)	£209.00

E&OE. All items are subject to VAT, where applicable.



# In Desk Power Modules

Finishes:



- Robust and elegant cast aluminium housing available in white, silver or black with matching cover plate
- 70% faster charging with True Fast Charge
- Single or double 240V power socket protected by our unique tool activated reset
- 100W USB-C Synapse™ smart functionality available, 30W USB-C and 27W USB-A as standard
- 0.5m cable with GST connector
- Ergonomic design presents sockets at the optimum angle for ease of use
- Designed to go beyond what is required by BS6396:2022, and consequently are the safest products on the market
- Doesn't fit standard desking cable ports. Recommended for Kuddle and boardroom table ranges
- **Supplied with 3m mains lead**

White/White	Black/Black	Silver/Grey	Description	RRP
NEXBUN004WH	NEXBUN004BK	NEXBUN004GR	Single socket, 1 x 30W USB-C, 1 x 27W USB-A	£138.00
NEXBUN005WH	NEXBUN005BK	NEXBUN005GR	Double socket	£82.00
NEXBUN006WH	NEXBUN006BK	NEXBUN006GR	Single socket, 1 x USB-C 100W Synapse power & data, 1 x 27W USB-A	£209.00

# Round In Desk Power Modules



Finishes:



- Aluminium housing and decorative veneer available in white, silver or black to suit your aesthetic
- 70% faster charging with True Fast Charge
- 240V power socket protected by unique tool activated reset
- 100W USB-C Synapse™ smart functionality available (requires additional hub), 30W USB-C and 27W USB-A as standard
- 0.5m cable with GST connector
- Fits into an industry standard 80mm grommet hole
- Future proof design allows data or AV to be added on site
- Designed to go beyond the requirement of BS6396:2022, and consequently are the safest products on the market
- **Supplied with 3m mains lead**

White/White	Black/Black	Silver/Grey	Description	RRP
NEXBUN007WH	NEXBUN007BK	NEXBUN007GR	Single socket, 30W USB-c, 27W USB-A	£130.00
NEXBUN008WH	NEXBUN008BK	NEXBUN008GR	Single socket, 30W USB-c, 27W USB-A, additional USB-C blank slot	£126.00
NEXBUN009WH	NEXBUN009BK	NEXBUN009GR	Single socket, 30W USB-c, 27W USB-A, additional RJ45 blank slot	£128.00
NEXBUN010WH	NEXBUN010BK	NEXBUN010GR	Single socket, 30W USB-c, 27W USB-A, additional USB-A blank slot	£132.00

# Desk Accessories

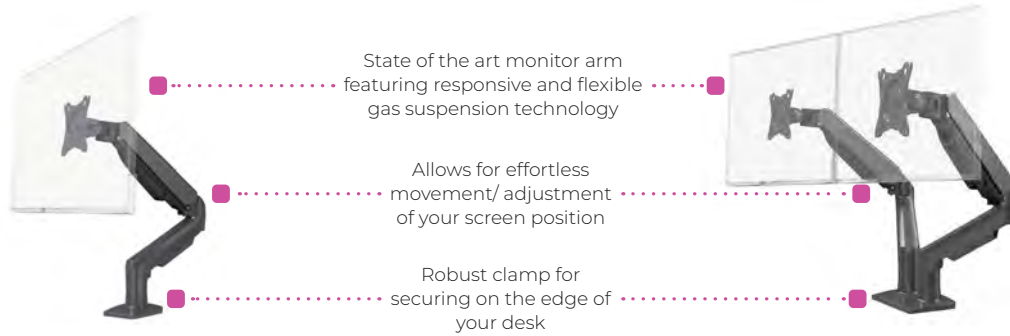

## Single Gas Spring Monitor Arm

Code	RRP
MERGE01 Available in black only	£60.00

## Twin Gas Spring Monitor Arm

Code	RRP
MERGE02 Available in black only	£100.00

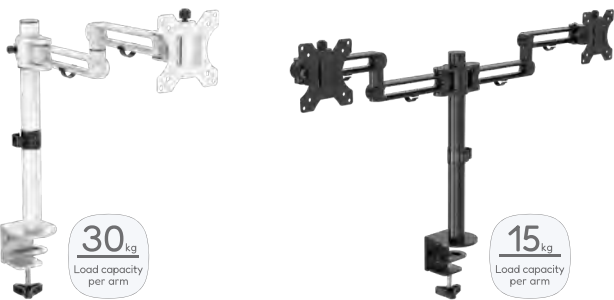

## Pole Mounted Monitor Arms

Code	Arms	RRP
MBMA	Single Available in black, silver or white	£141.00
MBTA	Twin Available in black, silver or white	£183.00



## Spring Assisted Monitor Arms

Code	Arms	RRP
SGAMA	Single Available in black or white	£221.00
TGAMA	Twin Available in black or white	£337.00

Screens must be the same make, size and weight on either side of the Twin Arms

## Basket Style Cable Tray

Code	Width	RRP
NTC701110800S-01 For 1000 desk	800	£64.00
NTC70111000S-01 For 1200 desk	1000	£69.00
NTC70111200S-01 For 1400 desk	1200	£78.00
NTC70111400S-01 For 1600 desk	1400	£85.00
NTC70111600S-01 For 1800 desk	1600	£93.00

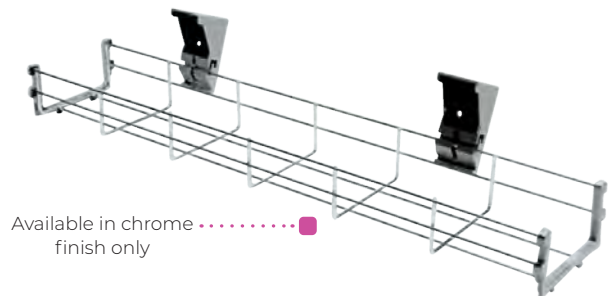

## 50mm Cable Spine - 760mm

Code	RRP
NEX7031B-01 Black	£41.00
NEX7031G-01 Grey	£41.00
NEX7031W-01 White	£41.00



## Articulated Cable Spine - 130mm

Code	RRP
NEX7033B-01 Black	£77.00
NEX7033G-01 Grey	£77.00
NEX7033W-01 White	£77.00

E&OE. All items are subject to VAT, where applicable.



# Coat Stands



## Cluster Coat Stand

Code	Height	RRP
COATSTAND6	1820	£165.00

- Thick tubular steel construction
- Easy self assembly - no tools required
- Integral umbrella stands and weighted base for added stability



## Chromy Coat Stand

Code	Height	RRP
COATSTAND2	1770	£303.00

- Thick tubular steel construction
- Easy self assembly - no tools required
- Integral umbrella stands and weighted base for added stability



## Festival Coat Stand

Code	Height	RRP
COATSTAND3	1870	£182.00
COATSTAND4	1870	£175.00

- Thick tubular steel construction
- Easy self assembly - no tools required
- Integral umbrella stands and weighted base for added stability



## Wooden Coat Stand

Code	Height	RRP
COATSTAND5	1750	£175.00

- Six coat pegs with four mini pegs for accessories
- Smart umbrella holder and hook
- Weighted base for extra stability
- Easy assembly - no tools required

# Titan Education Collection

// 07

Learning environments are always evolving and our educational furniture supports that transformation. Designed for flexibility and collaboration, our furniture adapts to various teaching styles and classroom layouts.







**Arc 4-Leg**  
page 289



**Arc Mobile 4-Leg**  
page 289



**Arc Reverse Cantilever**  
page 289



**Arc Skid**  
page 289



**Arc High Stool**  
page 291



**Arc Dynamic 3D Tilt**  
page 291



**Arc Community**  
page 291



**Arc Swivel**  
page 291



**Arc Wooden 4 Leg**  
page 292



**Arc Spin Stool**  
page 292



**Arc High Density Stacker**  
page 293



**Maker Tables**  
page 295



**Titan One Piece & Retold**  
pages 296-297



**Titan Skid**  
page 298



**Titan 4-Leg**  
page 299



**Titan Stool**  
page 300



**Titan High Chair**  
page 301



**Titan T-Bag**  
page 302



**Titan Swivel**  
page 303



**Crush Bent Classroom Tables**  
page 304



**Fully Welded Classroom Tables**  
page 305



**Flat-pack Classroom Tables**  
page 307



**Exam Desks**  
page 309



**Storage Trays**  
page 310



**Teacher Walls**  
pages 312-313



**Seat Pads**  
page 314



**Arc Frame Options**  
page 316



**Accessories**  
page 317



# Arc

Polypropylene seat finishes:



FOR SEAT PADS  
page 314

10  
Stacks up to  
10 high



## 4-Leg

	<b>TA1_5 //</b> Arc Four Leg size 5	<b>TA1_6 //</b> Arc Four Leg size 6
Seat	W425 D410 H430	W425 D410 H460
Back	W405 H425	W405 H425
FR	UL94 V-2	UL94 V-2

10  
Stacks up to  
10 high



## 4-Leg with Brace

	<b>TA2_5 //</b> Arc Four Leg size 5	<b>TA2_6 //</b> Arc Four Leg size 6
Seat	D410 W425 H430	D410 W425 H460
Back	W405 H425	W405 H425
FR	UL94 V-2	UL94 V-2

6  
Stacks up to  
6 high



## Mobile 4-Leg

	<b>TA6 //</b> Arc Mobile Four Leg size 6
Seat	W425 D410 H460
Back	W405 H425
FR	UL94 V-2



## Reverse Cantilever

	<b>TA4_5 //</b> Arc Reverse Cantilever size 5	<b>TA4_6 //</b> Arc Reverse Cantilever size 5
Seat	D410 W425 H430	D410 W425 H460
Back	W405 H425	W405 H425
FR	UL94 V-2	UL94 V-2

8  
Stacks up to  
8 high



## Skid

	<b>TA3_5 //</b> Arc Skid size 5	<b>TA3_6 //</b> Arc Skid size 6
Seat	W425 D410 H430	W425 D410 H460
Back	W405 H425	W405 H425
FR	UL94 V-2	UL94 V-2

4  
Stacks up to  
4 high



## High Stool

	<b>TA5_5 //</b> Arc High Stool size 5	<b>TA5_6 //</b> Arc High Stool size 6
Seat	D410 W425 H610	D410 W425 H685
Back	W405 H425	W405 H425
FR	UL94 V-2	UL94 V-2



ROOM A

ROOM B

# Arc

Polypropylene seat finishes:



FOR SEAT PADS  
page 314



## Dynamic 3D Tilt

	<b>TA7_6 // Arc Dynamic 3D Tilt size 6</b>
Seat	W425 D410 H445-538
Back	W405 H425
Mechanism	3D Tilt
FR	UL94 V-2



## Dynamic 3D Tilt & Personal Workspace

	<b>TA8_6 // Arc Dynamic 3D Tilt &amp; Personal Workspace size 6</b>
Seat	W425 D410 H470-535
Back	W405 H425
Mechanism	3D Tilt
FR	UL94 V-2



## Community

	<b>TA9_6 // Arc Community size 6</b>
Seat	W425 D410 H470
Back	W405 H425
FR	UL94 V-2



## Community & Personal Workspace

	<b>TA10_6 // Arc Community &amp; Personal Workspace size 6</b>
Seat	W425 D410 H470
Back	W405 H425
FR	UL94 V-2



## Swivel

	<b>TA11_6 // Arc Swivel size 6</b>
Seat	W425 D410 H-795-890
Back	W405 H425
FR	UL94 V-2



## Swivel & Personal Workspace

	<b>TA12_6 // Arc Swivel &amp; Personal Workspace size 6</b>
Seat	W425 D410 H820-890
Back	W405 H425
FR	UL94 V-2

# Arc Wooden



Seat finishes:



**Arc Wooden 4 Leg**

	<b>TA13_5 // Arc Wooden size 5</b>	<b>TA13_6 // Arc Wooden size 6</b>
Seat	W425 D410 H430	W425 D410 H460
Back	W405 H425	W405 H425
FR	UL94 V-2	UL94 V-2



**Arc Wooden 4 Leg with Arms**

	<b>TA15_5 // Wooden with Arms size 5</b>	<b>TA15_5 // Wooden with Arms size 6</b>
Seat	D410 W425 H430	D410 W425 H460
Back	W405 H425	W405 H425
FR	UL94 V-2	UL94 V-2

# Arc Spin Stool

Seat finishes:



The Arc Spin Stool combines adaptability, mobility, and comfort. Its modern design seamlessly fits into a variety of educational settings, promoting dynamic seating. Easy to move, it encourages collaboration and flexibility.



	<b>TA16 // Arc Spin stool</b>
Seat	H480
Overall	D445 W325 H505
FR	Low

# Arc High Density

Seat finishes:

- BK
  - WH
  - GR
  - BL
  - PK
  - RD
  - GN
  - SB
  - CR
- Anthracite Black    White    Grey    Navy Blue    Pink    Coral Red    Green    Steel Blue    Cream

40

Stacks up to  
40 high

5

YR

Component  
Guarantee

115

KG

Weight  
Tolerance

8

Hours  
Usage

100%

Recyclable

Anti-  
Microbial

★  
**NEW**  
 FOR 2025



## Stacker Chair

	<b>TA17 // Arc High Density Stacker Chair</b>	<b>TA17LINK // Arc High Density Linking Clip   Black</b>
Overall	W510 D460 H805	
Seat	W425 D400 H455	
Back	W420 H285	
FR	Low	
Material	Polypropylene	
Storage	Stacks up to 40 high	
		<b>TA17SPUN // Arc High Density Stacker Seat Pad</b>

## Trolley

	<b>TA17TROLLEY // Arc High Density Trolley</b>
Overall	W620 D890 H850
FR	Low
Material	Polypropylene



**Like this chair?**  
 Arc High Density Stacker chair (TA17) shown with optional seat pad







# Maker Tables

Made to order top finishes:



Frame finishes:

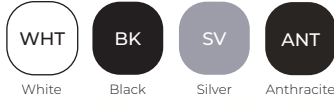

**NEW**  
GRAPHITE  
FRAME  
FOR  
2025



**Low Maker Tables**

Code	Dimensions
T-LOW-M-1210	W1000 D1200 H740
T-LOW-M-1510	W1000 D1500 H740
T-LOW-M-1810	W1000 D1800 H740



**Low Mobile Maker Tables**

Code	Dimensions
T-LOW-MM-1210	W1000 D1200 H740
T-LOW-MM-1510	W1000 D1500 H740
T-LOW-MM-1810	W1000 D1800 H740



**High Maker Tables**

Code	Dimensions
T-HIGH-M-1210	W1000 D1200 H1100
T-HIGH-M-1510	W1000 D1500 H1100
T-HIGH-M-1810	W1000 D1800 H1100



**High Mobile Maker Tables**

Code	Dimensions
T-HIGH-MM-1210	W1000 D1200 H1100
T-HIGH-MM-1510	W1000 D1500 H1100
T-HIGH-MM-1810	W1000 D1800 H1100

## Titan Mobile Tables

Code	Dimensions
T-MOBILE-1260	W1200 D600 H733
T-MOBILE-1280	W1200 D800 H733
T-MOBILE-1460	W1400 D600 H733
T-MOBILE-1480	W1400 D800 H733
T-MOBILE-1660	W1600 D600 H733
T-MOBILE-1680	W1600 D800 H733
T-MOBILE-1860	W1800 D600 H733
T-MOBILE-1880	W1800 D800 H733



# Titan One Piece - Retold



Polypropylene finish:

**RBK**  
Black

Independently certified for strength, stability, and ergonomics

Made from **100% recycled** One Piece Chairs

Ideal for educational spaces, promoting sustainability

Crafted from recycled Titan chairs, diverts 15 tonnes of plastic annually



	T5-RBK // One Piece Retold size 5	T6-RBK // One Piece Retold size 6
Overall	W480 D486 H799	W482 D510 H829
Seat	W379 D414 H430	W370 D414 H460
Back	W400 H435	W400 H435
Weight capacity	115kg	158kg
FR	Low	Low
Material	Polypropylene	Polypropylene



**15 tonnes** of plastic saved from landfill

# Titan One Piece



Polypropylene finishes:



**FOR LINKING CLIPS**  
page 317



	<b>T1 // One Piece size 1</b> 3-4 years	<b>T2 // One Piece size 2</b> 4-6 years	<b>T3 // One Piece size 3</b> 6-8 years	<b>T4 // One Piece size 4</b> 8-11 years	<b>T5 // TA5-AN One Piece size 5</b> 11-14 years	<b>T6 // TA6-AN One Piece size 6</b> 14+ years
Overall	W360 D310 H510	W360 D345 H555	W430 D420 H655	W430 D430 H685	W470 D500 H770	W470 D530 H805
Seat	W280 D250 H265	W280 D250 H310	W340 D330 H355	W340 D330 H385	W370 D380 H425	W370 D380 H460
Back	W300 H310	W300 H310	W370 H380	W370 H380	W400 H435	W400 H435
Weight capacity	97kg	97kg	107kg	107kg	115kg	158kg
FR	Low	Low	Low	Low	Low	Low
Material	Polypropylene	Polypropylene	Polypropylene	Polypropylene	Polypropylene	Polypropylene
Finishes available	GN, B, R, Y, UN	GN, B, R, Y, L, P, C, UN	GN, B, R, Y, L, CB, P, C, UN	GN, B, R, Y, L, CB, P, C, O, UN	All finishes	All finishes



**FOR EXAM DESKS**  
page 309



# Titan Skid

Polypropylene finishes:



**FOR SEAT PADS**  
page 314



	<b>T23 // Skid size 3</b>	<b>T24 // Skid size 4</b>	<b>T25 // Skid size 5</b>	<b>T26 // Skid size 6</b>
Age	6-7 years	8-11 years	11-14 years	14+ years
Overall	W510 D380 H655	W510 D380 H510	W545 D485 H690	W545 D495 H820
Seat	W387 D296 H360	W380 H380 H385	W423 D365 H430	W423 D365 H430
Back	W364 H313	W364 H313	W413 H369	W413 H369
Weight capacity	95kg	95kg	140kg	140kg
FR	Low	Low	Low	Low
Material	Polypropylene/ Steel	Polypropylene/ Steel	Polypropylene/ Steel	Polypropylene/ Steel
Finishes available	GN, B, P, R, O, Y, L, CB, C, UN	GN, B, P, R, O, Y, L, CB, C, UN	All finishes	All finishes

# Titan 4-Leg



Polypropylene finishes:



FOR SEAT PADS  
page 314



	T12 // 4-Leg size 2	T13 // 4-Leg size 3	T14 // 4-Leg size 4	T15 // 4-Leg size 5	T16 // 4-Leg size 6
Age	4-6 years	6-8 years	8-11 years	11-14 years	14+ years
Overall	W430 D360 H630	W420 D375 H665	W430 D410 H695	W500 D475 H785	W500 D475 H825
Seat	W380 D296 H320	W380 D296 H350	W387 D296 H385	W420 D365 H420	W420 D365 H460
Back	W364 H313	W364 H313	W364 H313	W413 H369	W413 H369
Weight capacity	95kg	95kg	95kg	140kg	140kg
FR	Low	Low	Low	Low	Low
Material	Polypropylene/ Steel	Polypropylene/ Steel	Polypropylene/ Steel	Polypropylene/ Steel	Polypropylene/ Steel
Finishes available	GN, B, P, R, O, Y, L, CB, C, UN	GN, B, P, R, O, Y, L, CB, C, UN	GN, B, P, R, O, Y, L, CB, C, UN	All finishes	All finishes

## Titan 4-Leg (Move)



### T301 // 4-Leg Move

Age	14+ years
Overall	W520 D495 H830
Seat	W420 D365 H445
Back	W413 H369
Weight capacity	130kg
FR	Low
Material	Polypropylene/ Steel
Finishes	All finishes



# Titan Stool

Polypropylene finishes:

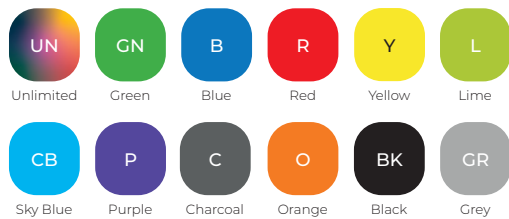

**FOR SEAT PADS**  
page 314



	<b>T90 // Titan Stool size 3</b>	<b>T91 // Titan Stool size 4</b>	<b>T92 // Titan Stool size 5</b>	<b>T93 // Titan Stool size 6</b>
Age	6-8 years	8-11 years	11-14 years	14+ years
Overall	W485 D485 H520	W485 D485 H650	W485 D485 H685	W485 D485 H770
Seat	W365 D361 H435	W365 D361 H565	W365 D361 H610	W365 D361 H690
Weight capacity	97kg	97kg	107kg	107kg
FR	Low	Low	Low	Low
Material	Polypropylene/ Steel	Polypropylene/ Steel	Polypropylene/ Steel	Polypropylene/ Steel

# Titan High Chair

Polypropylene finishes:

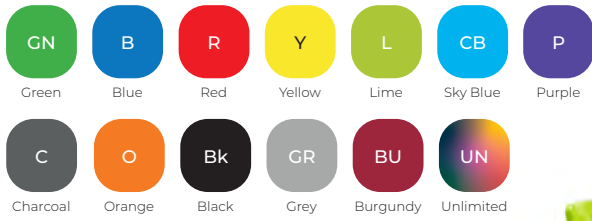

FOR SEAT PADS  
page 314



	T60 // High chair size 3	T61 // High chair size 4	T62 // High chair size 5	T63 // High chair size 6
Age	6-8 years	8-11 years	11-14 years	14+ years
Overall	W485 D485 H845	W485 D485 H955	W485 D485 H1010	W485 D485 H1085
Seat	W380 D296 H455	W380 D296 H570	W423 D365 H615	W423 D365 H690
Back	W413 H369	W413 H369	W413 H369	W413 H369
Weight capacity	95kg	95kg	140kg	140kg
FR	Low	Low	Low	Low
Material	Polypropylene/ Steel	Polypropylene/ Steel	Polypropylene/ Steel	Polypropylene/ Steel





# Titan T-Bag

Finishes:



## Goliath Bag

	<b>T-BAG-GOLIATH // Goliath Bag</b>
Overall	W1320 D2000 H200
Material	15 cuft polybead filling



## Medium Bag

	<b>T-BAG-MEDIUM // Medium Bag</b>
Overall	W750 D750 H650
Material	3.5 cuft polybead filling



## Floor Bag

	<b>T-BAG-FLOOR // Floor Bag</b>
Overall	W680 H680
Material	1.5 cuft polybead filling

E&OE. All items are subject to VAT, where applicable.



# Titan Swivel



Polypropylene finishes:

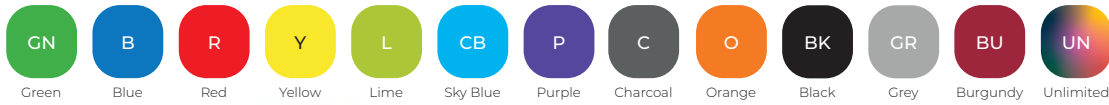

Made from **100% recycled** One Piece Chairs



Glides available - contact us for details

## Swivel

Junior	T30 // Junior Swivel Chair Chrome Base	T30BK // Junior Swivel Chair Black Base
Age	6-11 years	6-11 years
Seat	W380 D296 H380-460	W380 D300 H390-455
Back	W350 H330	W350 H330
Base Dia	600	600
Weight capacity	97kg	97kg
Finishes available	GN, B, P, R, O, Y, L, CB, C, UN	GN, B, P, R, O, Y, L, CB, C, UN

Senior	T35 // Senior Swivel Chair Chrome Base	T35BK // Senior Swivel Chair Black Base
Age	11+ years	11+ years
Seat	W423 D365 H420-510	W420 D370 H410-540
Back	W400 H395	W400 H395
Base Dia	600	600
Weight capacity	107kg	107kg
Finishes available	GN, B, P, R, O, Y, L, CB, C, BK, GR, BU, UN	GN, B, P, R, O, Y, L, CB, C, BK, GR, BU, UN
Optional D-Kits	AC1014 (Fixed) AC1042 (Adjustable)	AC1014 (Fixed) AC1042 (Adjustable)

## Swivel Stool

Junior	T32 // Junior Swivel Stool Chrome Base	T32BK // Junior Swivel Stool Black Base
Age	6-11 years	6-11 years
Seat	W365 D361 H330-400	W365 D361 H360-425
Base Dia	600	600
Weight capacity	97kg	97kg
Finishes available	GN, B, P, R, O, L, CB, C, BK, GR, UN	GN, B, P, R, O, L, CB, C, BK, GR, UN

Senior	T33 // Senior Swivel Stool Chrome Base	T33BK // Senior Swivel Stool Black Base
Age	11+ years	11+ years
Seat	W365 D361 H390-480	W365 D361 H400-530
Base Dia	600	600
Weight capacity	97kg	97kg
Finishes available	GN, B, P, R, O, L, CB, C, BK, GR, UN	GN, B, P, R, O, L, CB, C, BK, GR, UN





# Crush Bent Classroom Tables

Stocked top finishes | Stocked frame finish:



- Crushed, bent steel frame
- Can be placed side by side without any gaps
- Durable 18mm MDF top on a MDF top
- Supplied pre-built
- Stacks up to 10 high



**1200 x 600**

**Code**

T-CB1271  
T-CB1276

**Dimensions**

W1200 D600 H710  
W1200 D600 H760



# Fully Welded Classroom Tables

Stocked top finishes | Stocked frame finish:



- Fully welded steel frame
- Can be placed side by side without any gaps
- Durable 18mm MDF top
- Bull-nosed polished edges covered with a high-quality laminate finish
- Supplied pre-built
- Can be Spiral Stacked



1100 x 550

Code	Dimensions
T-FW1571	W1100 D550 H710
T-FW1576	W1100 D550 H760



600 x 600

Code	Dimensions
T-FW6071	D600 W600 H710
T-FW6076	D600 W600 H760



1200 x 600

Code	Dimensions
T-FW1271	W1200 D600 H710
T-FW1276	W1200 D600 H760



Stocked finish | Made to order finishes:

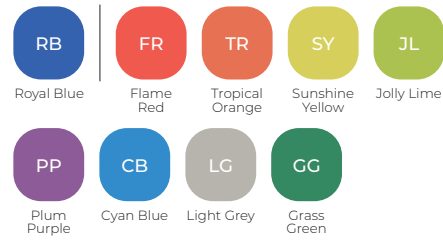

## Welded Table Trays

Code	Dimensions
1TBUN	1 tray bundle W1200 D600 H590
2TBUN	2 tray bundle W600 D600 H590

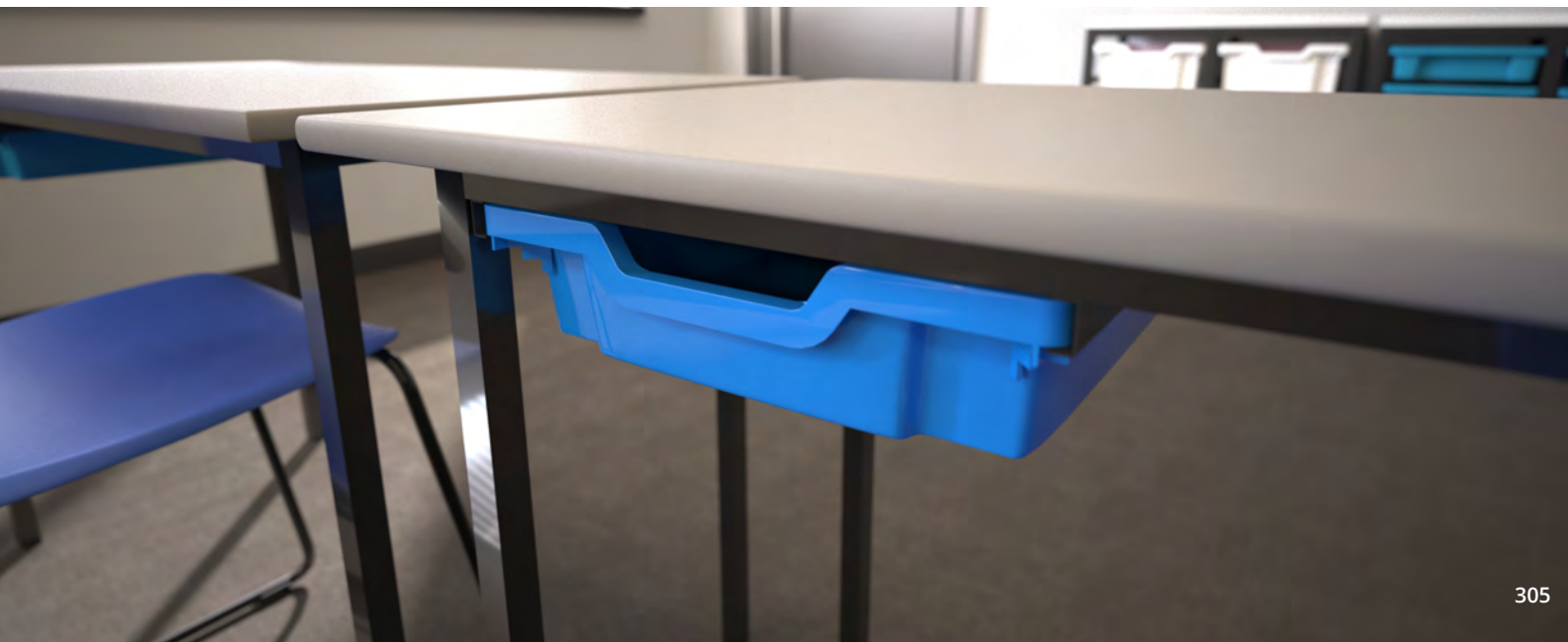





# Flat-pack Classroom Tables

Stocked top finishes | Stocked frame finish:



- Available in six heights
- Flat pack design
- Metal to metal fixings for strength
- PU moulded edge



**460 High PU Edge Tables**

Code		Dimensions
T-TABLE-1246	Rectangular table	W1200 D600 H460
T-TABLE-6046	Square table	W600 D600 H460



**530 High PU Edge Tables**

Code		Dimensions
T-TABLE-1253	Rectangular table	W1200 D600 H530
T-TABLE-6053	Square table	W600 D600 H530



**590 High PU Edge Tables**

Code		Dimensions
T-TABLE-1259	Rectangular table	W1200 D600 H590
T-TABLE-6059	Square table	W600 D600 H590



**640 High PU Edge Tables**

Code		Dimensions
T-TABLE-1264	Rectangular table	W1200 D600 H640
T-TABLE-6064	Square table	W600 D600 H640



**710 High PU Edge Tables**

Code		Dimensions
T-TABLE-1271	Rectangular table	W1200 D600 H710
T-TABLE-6071	Square table	W600 D600 H710



**760 High PU Edge Tables**

Code		Dimensions
T-TABLE-1276	Rectangular table	W1200 D600 H760
T-TABLE-6076	Square table	W600 D600 H760



# Exam Desks

## Polypropylene Exam Desk

Stocked top finishes | Stocked frame finish:



Graffiti proof wipe clean injection moulded polypropylene top with pen groove and ultra-strong 22mm diameter black EPC folding frame

Code	Dimensions
T10	W600 D600 H710

## MDF Exam Desk

Stocked top finishes | Stocked frame finish:



18mm thick beech laminate MDF with pen groove, 22mm diameter black EPC frame with integral safety bar to assist safer folding and storage

Code	Dimensions
TC66ED-PREM-720	W600 D600 H720

## Economy MDF Exam Desk

Stocked top finishes | Stocked frame finish:



15mm thick beech laminate MDF with pen groove, 22mm diameter black EPC frame

Code	Dimensions
TC66ED-ECON-720-NS	W600 D600 H720

## Exam Desk Trolley

Finish:



Capacity: 20 exam desks

Code	Dimensions
TCEDT-20T	W660 D1225 H1150

## Exam Desk Trolley

Finish:



Capacity: 40 exam desks

Code	Dimensions
TCEDT-20T	W660 D1225 H1150

## Exam Desk Trolley

Finish:



Capacity: 50 exam desks

Code	Dimensions
TCEDT-20T	W660 D1225 H1150

# Storage Trays

Stocked finish | Made to order finishes:

- RB

Royal Blue
- FR

Flame Red
- TO

Tropical Orange
- SY

Sunshine Yellow
- JL

Jolly Lime
- GG

Grass Green
- PP

Plum Purple
- CB

Cyan Blue
- LG

Light Grey



## Small Storage Trays

	<p><b>T-STOR-6D-F01BLUE // Small 6 Trays</b></p>	<p><b>T-STOR-12D-F01BLUE // Small 12 Trays</b></p>	<p><b>T-STOR-18D-F01BLUE // Small 18 Trays</b></p>
Overall	W390 D438 H795	W748 D438 H795	W1106 D438 H795
Trays	6 Trays	12 Trays	18 Trays



## Medium Storage Trays

	<p><b>T-STOR-3D-F02BLUE // Medium 3 Trays</b></p>	<p><b>T-STOR-6D-F02BLUE // Medium 6 Trays</b></p>	<p><b>T-STOR-9D-F02BLUE // Medium 9 Trays</b></p>
Overall	W390 D438 H795	W748 D438 H795	W1106 D438 H795
Trays	3 Trays	6 Trays	9 Trays



## Large Storage Trays

	<p><b>T-STOR-2D-F25BLUE // Large 2 Trays</b></p>	<p><b>T-STOR-4D-F25BLUE // Large 4 Trays</b></p>	<p><b>T-STOR-6D-F25BLUE // Large 6 Trays</b></p>
Overall	W390 D438 H795	W748 D438 H795	W1106 D438 H795
Trays	2 Trays	4 Trays	6 Trays







### Classic Teacher Wall

TTWBUN01 // Classic Media Wall

Overall	D600 W4036 H2100
Material	MFC
FR	Low



### Sliding Door Teacher Wall

TTWBUN02 // Sliding Door Media Wall

Overall	D600 W4036 H2100
Material	MFC
FR	Low

# Teacher Walls

Made to order colour finishes | MTO wood grain finishes:

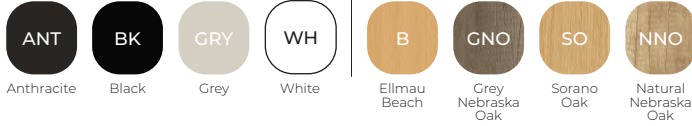

- Designed to create stylish, adaptable, and contemporary storage and organisation solutions
- Available in eight distinct finishes
- Five module configurations to choose from



## Complete Teacher Wall

TTWBUN03 // Complete Media Wall

Overall	D600 W4036 H2100
Material	MFC
FR	Low



## Open Teacher Wall

TTWBUN04 // Open Media Wall

Overall	D600 W4036 H2100
Material	MFC
FR	Low



# Seat Pads

The Titan padded seat pad is the perfect addition to Titan chairs ranging from size three to size five. Available in unlimited fabric, these seat pads are upholstered in the UK to a colour and texture of your choosing to make learning a little bit more comfortable.

## Titan One Piece seat pad

Code	Size
T8-3/4UN	One Piece Junior (Sizes 3 & 4)
T8-5/6UN	One Piece Senior (Sizes 5 & 6)

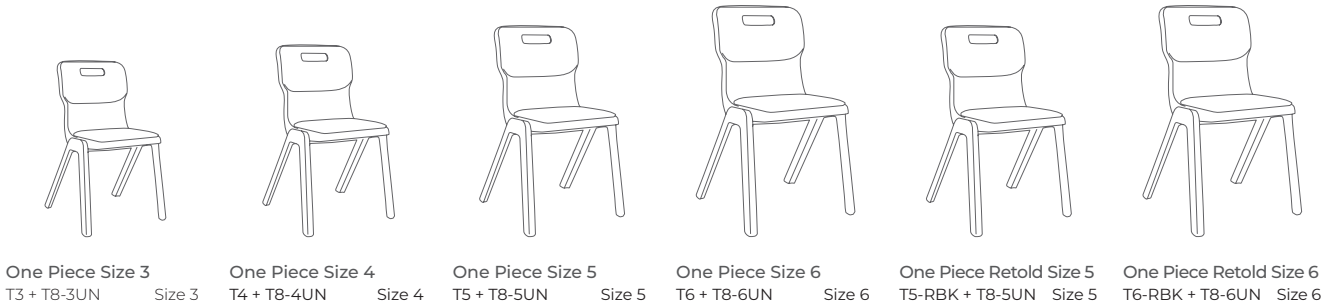

One Piece Size 3  
T3 + T8-3UN Size 3

One Piece Size 4  
T4 + T8-4UN Size 4

One Piece Size 5  
T5 + T8-5UN Size 5

One Piece Size 6  
T6 + T8-6UN Size 6

One Piece Retold Size 5  
T5-RBK + T8-5UN Size 5

One Piece Retold Size 6  
T6-RBK + T8-6UN Size 6

## Titan seat pad

Code	Size
T8-JSUN	Titan Junior (Sizes 3 & 4)
T8-ASUN	Titan Senior (Sizes 5 & 6)

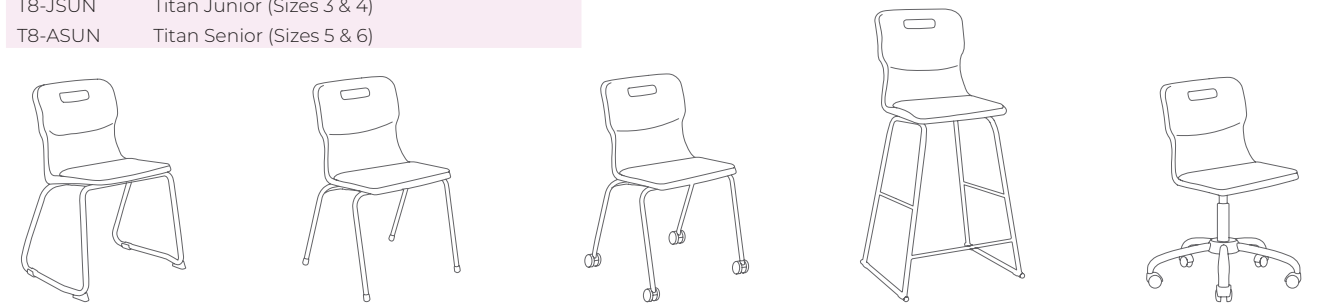

Titan Skid  
T23 + T8-JSUN Size 3  
T24 + T8-JSUN Size 4  
T25 + T8-ASUN Size 5  
T26 + T8-ASUN Size 6

Titan 4-Leg  
T13 + T8-JSUN Size 3  
T14 + T8-JSUN Size 4  
T15 + T8-ASUN Size 5  
T16 + T8-ASUN Size 6

Titan 4-Leg Move  
T301 + T8-ASUN Size 6

Titan High Chair  
T60 + T8-JSUN Size 3  
T61 + T8-JSUN Size 4  
T62 + T8-ASUN Size 5  
T63 + T8-ASUN Size 6

Titan Swivel  
T30 + T8-JSUN Size 3  
T30BK + T8-JSUN Size 4  
T35 + T8-ASUN Size 5  
T35BK + T8-ASUN Size 6

## Arc seat pad

Code	Size
TSAP	Arc seat pad (Sizes 5 & 7)

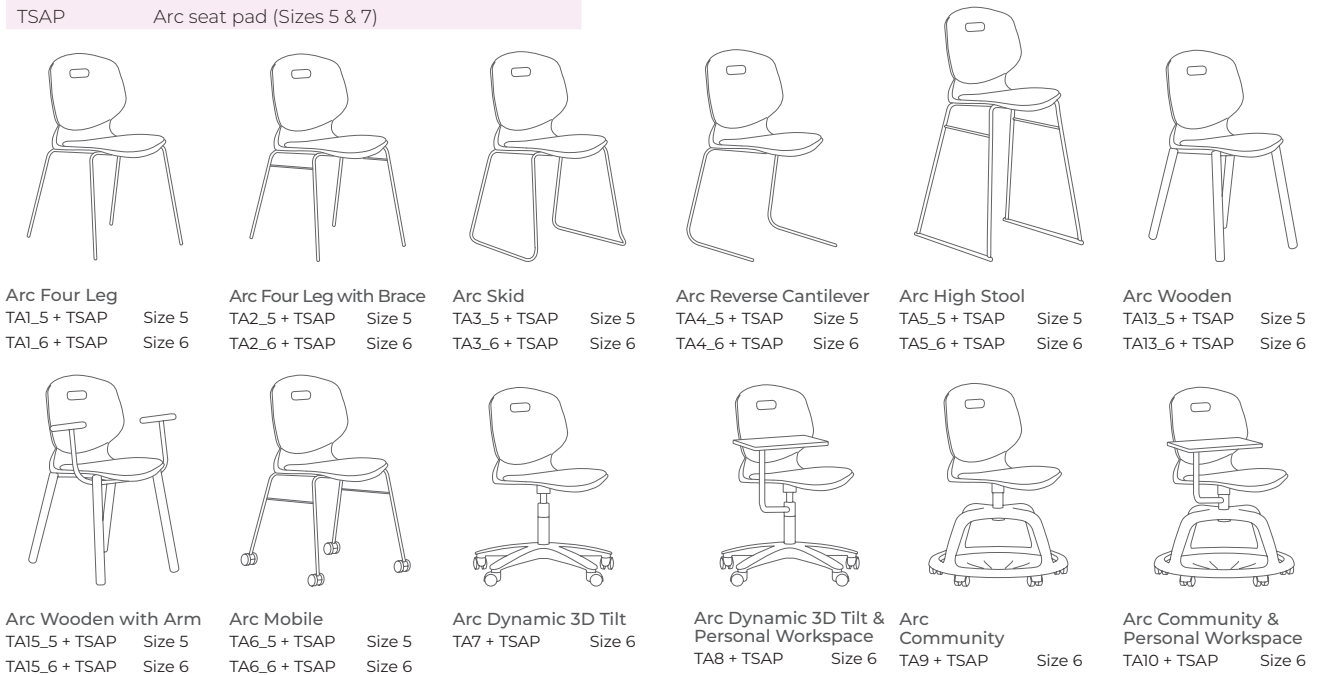

Arc Four Leg  
TA1\_5 + TSAP Size 5  
TA1\_6 + TSAP Size 6

Arc Four Leg with Brace  
TA2\_5 + TSAP Size 5  
TA2\_6 + TSAP Size 6

Arc Skid  
TA3\_5 + TSAP Size 5  
TA3\_6 + TSAP Size 6

Arc Reverse Cantilever  
TA4\_5 + TSAP Size 5  
TA4\_6 + TSAP Size 6

Arc High Stool  
TA5\_5 + TSAP Size 5  
TA5\_6 + TSAP Size 6

Arc Wooden  
TA13\_5 + TSAP Size 5  
TA13\_6 + TSAP Size 6

Arc Wooden with Arm  
TA15\_5 + TSAP Size 5  
TA15\_6 + TSAP Size 6

Arc Mobile  
TA6\_5 + TSAP Size 5  
TA6\_6 + TSAP Size 6

Arc Dynamic 3D Tilt  
TA7 + TSAP Size 6

Arc Dynamic 3D Tilt & Personal Workspace  
TA8 + TSAP Size 6

Arc Community  
TA9 + TSAP Size 6

Arc Community & Personal Workspace  
TA10 + TSAP Size 6



## Seat Fabric

The Fabric Seat Pad is available in an unlimited choice of fabrics and can help give the user better comfort as standard in Camira Phoenix. Other fabrics available, call sales for more details..

### Camira Phoenix Options

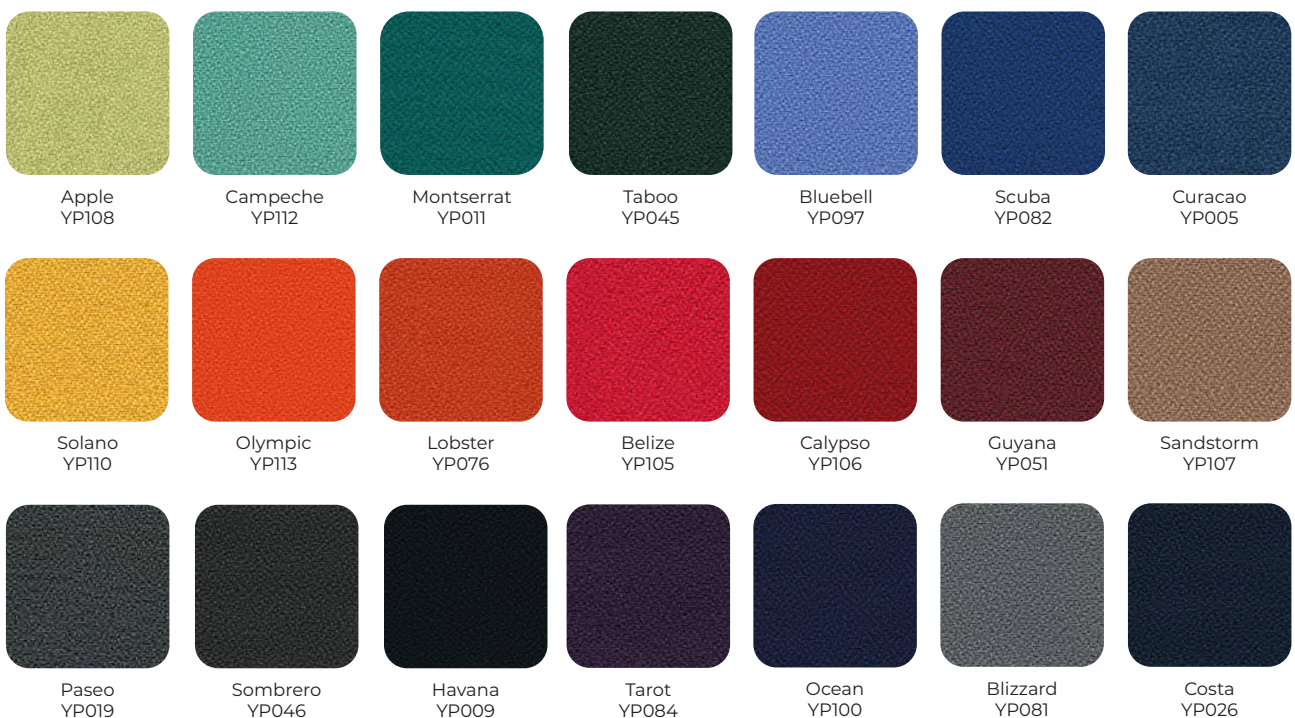

# Arc Frame Options

Our Arc chairs are available with coloured leg frames in any RAL colour. Choose to have matching seat shells and frames or mix and match to fit with the aesthetic you are looking for.



Matching shell and frame



Complimentary shell and frame



Complimentary shell and frame

RAL colours to match our shell options:						RAL colours to compliment our shell options:					
RAL 1017	RAL 3017	RAL 4007	RAL 6017	RAL 5009	RAL 9005	RAL 2000	RAL 3027	RAL 3015	RAL 6016	RAL 5012	RAL 7004





## Accessories



Compatible with the Titan One Piece



### Trolley

	<b>T40</b>
Overall	W650 D480 H1158
Capacity	15 chairs



### One Piece Linking Clip

	<b>T7</b>
Capacity	For one piece size 5 & 6



### Trolley Strap

	<b>TSTRAP5M</b>
Overall	L5000

# Index

Alto	15	Cable Tray	284
Arc 4-Leg Chair	107, 289	Call Centre Chair	31
Arc 4-Leg Chair with Brace	289	Calypso Chair (all except Calypso Ergo)	71
Arc Community Chair	291	Calypso Ergo Chair	38
Arc Dynamic 3D Tilt Chair	291	Canasta Chair Family	49
Arc Frame Options	316	Cannes Tilting Tables	208
Arc High Stool	107, 289	Canteen Chair	117
Arc High Density Stacker Chair & Trolley	65, 109, 293	Carbon Chair	18
Arc Mobile 4-Leg Chair	289	Cassis Tilting Tables	208
Arc Reverse Cantilever Chair	289	Chachi Chair	14
Arc Skid Chair	107, 289	Cheetah Chair	29
Arc Spin Stool	292	Club Chair Family	63
Arc Swivel Chair	291	Coat Stands	285
Arc Wooden 4-Leg Chair	106, 292	Concept Chair (all except Concept Plus)	68-69
Ares Chair	44	Concept Plus Chair	39
Aspect Chair	34	Contempo Screens	182
Astral High Table	113	Contract Tables	112, 207, 222
Astral Low Table	224	Core Bookcases	177
Aztec Pose Storage	155	Core Combination Cupboards	176
Aztec Back to Back Height Adjustable Desk	142	Core Cupboards	177
Aztec Cannes Tilting Tables	160	Core Double Upright Bundles	170-171
Aztec Cassis Tilting Tables	160	Core Double Upright Cantilever Leg Desks	173
Aztec Dual Motor Height Adjustable Desk	142	Core Filing Cabinets	179
Aztec Goalpost Leg Desks	141	Core Multi-purpose Tables	175
Aztec Multi-purpose Tables	163	Core Single Motor Height Adjustable Desks	174
Aztec Panel Leg Desks	148-149	Core Single Upright Bundles	166-167
Aztec Panel Plus Cupboards	158	Core Single Upright Cantilever Leg Desks	169
Aztec Panel Plus Desks	151	Core Steel Pedestals	179
Aztec Single Motor Height Adjustable Desk	143	Core Storage	178
Aztec Single Upright Leg Desks	146-147	Core Twin Motor Height Adjustable Desks	174
Aztec Twin Upright Leg Desks	144-145	Crush Bent Classroom Tables	304
Aztec Union Folding Tables	161	Curve Soft Seating Family	83
Aztec Wooden Bookcases	156	Dawn Chair Family	42-43
Aztec Wooden Cupboards	157	Deco Chair Family	53
Aztec Wooden Filing	153	Denali Chair Family	16-17
Aztec Wooden Pedestals	152	Divide Type 1 Screens	190
Aztec Wooden Tambours	159	Divide Type 2 Screens	191
Banqueting Chair	62	Economy Polypropylene Chair	117
Bearing Chair	35	Elco Screens	183
Bengal Chair Family	24-25	Ellipse Tables	111
Bisley A4 Home Filing	253	Exam Desks	309
Bisley Classic Filing	252	Factory Chair Family	72
Bisley Clean & Dirty Locker	262	Fan Back Folding Chair	64
Bisley Cloakroom Benches	265	Faze Chair	54
Bisley Combi Locker	262	Fire Resistant Safes	270-271
Bisley Contract Filing	252	Flat Back Folding Chair	64
Bisley Cupboards	258	Flat-pack Classroom Tables	307
Bisley Essentials Side Filers	257	Fleck Chair	47, 57
Bisley Essentials Tambours	257	Florence Chair	60
Bisley Lockers	260	Folding Chair Trolley	64
Bisley Lower Height Lockers	259	Fonseca Chair	19
Bisley MultiDrawers	254-255	Fonz Chair	26
Bisley Personal Filing	253	Fraction Infinity Tables	205
Bisley Police Locker	263	Fully Welded Classroom Tables	305
Bisley Primary Lockers	261	Glacier Chair	86
Bisley Steel Planter	256	Glacier Table	87, 224
Breeze Chairs, Stool & Tables Family	97-99	Guarda Boardroom Tables	213
Bubble Pods	242-243	Guise Chair	55
Button Soft Seating Family	89	Iceberg Soft Seating Family	85
Cable Spines	284	In-Desk Power Modules	283



Jack Chair Family	48	Screen Accessories	187
Jade Chair	79	Seat Pads	314
Jupiter Chair	60	Settle Chair	77
Keno Chair	46	Shift Chair	11
Kona Chair Family	81	Shoal Benches	100-101
Kuddle Armchair with Tablet	240	Sierra One Tables	212
Kuddle Cove Desk	234	Sosa Chair	56
Kuddle Glass Retreats	231	Spark Chair	21
Kuddle High Dens	237	Start Chair	18
Kuddle High Round Dens	239	Steel Lockers	269
Kuddle High Seating	241	Stem Chairs	52
Kuddle Low Dens	236	Stork Chair	113
Kuddle Low Round Dens	238	Strata Chair	27
Kuddle Open Retreats	232	Summit Meeting Chair	59
Kuddle Phonebooths	235	Sync Nested Coffee Tables	225
Kuddle Retreats	233	Synergy Back to Back Bench	124
Kuddle Soft Seating	92-93	Synergy Back to Back D-End	125
Ledge Stool & Table Family	103	Synergy Back to Back Extension	125
Lizzie Chair Family	104-105	Synergy Cable Channel	134
Lodge Booths	228-229	Synergy Cable Spine	134
Lyle Screens	184	Synergy Meeting Tables	133, 211
Magnum Screens	189	Synergy Modesty Panels	134
Maker Tables	199, 295	Synergy Single Bench	128
Maldini Chair Family	12-13	Synergy Single Extension	129
Marlos Chair	20	Synergy Single Return	129
Maxi Ergo Chair	36	Synergy Wooden Lockers	135
Media Units	276-277	Talos Cupboards	249
Media Walls	278-279	Talos Filing Cabinets	247
Mobile Screens	193	Talos Steel Pedestals	153, 246
Mobile Tables	206	Talos Tambours	248
Mode Chair	37	Tavern Chairs	103
Modular Reception Tops	217	Teacher Walls	312-313
Modular Reception Units	217	Titan 4-Leg Chair	299
Monitor Arms	284	Titan Accessories	317
Montana Chair	45	Titan High Chair	301
Morph Table & Chair Family	116	Titan One-Piece Chair	297
Multi-purpose Tables	205	Titan One-Piece Retold Chair	296
On-Desk Power Modules	282	Titan Skid Chair	298
Operator Chair Arms & Accessories	73	Titan Stool	300
Panel Screens	186	Titan Storage Trays	310
Panther Chair	28	Titan Swivel Chair & Stool	303
Pavia Chair	61	Titan T-Bags	302
Pavilion Chair	61	Tone Ceiling Hung Tiles	137, 188
Pearl Chair	79	Tone Desk Mounted Screens	137, 188
Personal Mobile Locker	135	Tone Wall Tiles	137, 188
Phonic Soft Seating Family	90-91	Toolrail Screens	185
Picasso Chair	110-111	Tripod Coffee Table	224
Picnic Table & Bench Family	112	Tub Lux Soft Seating Family	84
Plateau Table, Stool & Bench Family	114-115, 200-203	Tub Soft Seating Family	84
Platter Coffee Tables	223	Twilight Chair, Writing Tablet & Stacking Trolley	58
Pocket Chair	77	Union Folding Tables	209
Puma Chair	46	Veer Chair	59
Reception Coffee Tables	224	Versi Chair	70
Reception Unit	219	Vision Chair	19
Reception Unit with Extension	219	Vista Chair	30
Renoir Chair Family	62	Wooden Lockers	268
Repose Side Table	222	Zico Chair	21
Round In-Desk Power Modules	283	Zip Chair	11
Rubic Chair	87		
Safes	272-273		



**Like this chair?**

Guise chair (OF0605)  
can be found on page 55

# Sales & After Sales

---

## Pricing & Deliveries

- All pricing is subject to review. Please contact sales@tcgroupuk.com for your most up to date pricing
- Standard carriage charges may apply, please contact sales@tcgroupuk.com for confirmation of carriage charges
- Some areas of Scotland, Highlands & Islands, Channel Islands, Isle of Man, Cornwall & Ireland may incur additional carriage - price on application
- We will endeavour to deliver and/or install (where applicable) goods within any delivery or installation time specified. That time is an estimate and not a term of contract
- In no event whatsoever will we be liable for any delay in deliveries or installations and will not accept any invoices from the buyer
- Whilst every effort is made to ensure we meet delivery terms, there may be instances beyond our control that could affect this. We shall not be held liable for such delays and any costs incurred. Orders despatched and later cancelled due to such delays, will incur charges
- Please note palletised deliveries may be made by an articulated vehicle
- All palletised deliveries are kerbside only
- Should a delivery or installation not be fulfilled, due to one of the reasons below, without prejudice to any other rights or remedies available to the seller, the buyer may arrange with us to store the goods until required and we will charge the buyer for the reasonable costs of storage and redelivery charges (including insurance):
  - Refuses/fails to take delivery of the goods
  - Fails to provide adequate labour and facilities for the safe unloading of the goods
  - Fails to provide adequate delivery instructions at the time of order
- For D&I orders, if the fitters are unable to access the installation area, they will wait 30 minutes after which they may be required to move on. Our D&I team will call to re-arrange a more convenient date however failed installation costs may be incurred (minimum of £50.00) and will be invoiced to the buyer. The failed cost will be confirmed to the buyer in writing

## Cancellations, Samples & Special Fabrics

- Sample orders can be placed as normal orders. If the buyer wishes to return the product it will be subject to our standard returns policy and charges may apply
- Wood samples are available upon request
- At times it may be necessary to make changes to the internal specifications of our products and we reserve the right to make such changes
- Next day order cancellations are subject to our discretion due to our despatch process. For any changes made thereafter, we will endeavour to process these changes however we reserve the right to pass on any costs we may incur
- You have a 24-hour period to make any amendments and/or cancellations to any made to order or manufactured products. We will endeavour to process any cancellations and/or amendments made however we reserve the right to pass on any costs we incur. In the event of any delays outside of our control we are unable to accept any cancellations and/or amendments and we reserve the right to pass on any costs we may incur
- For confirmation of fabric availability and lead times please contact sales@tcgroupuk.com
- No responsibility can be accepted for slight variations, which add to the features of our chairs including but not limited to the following: On certain leather finishes there may be shade variations and small blemishes found in the leather which are a unique characteristic of a natural material and not a defect or weakness. Scratches and marks may occur through everyday use and seat covers will mould to body shapes which is a feature of natural leathers.

## Reporting Times & Claim Terms

- It is the responsibility of the buyer to ensure all deliveries and installations, whether they are to the buyer or a third party, are fully checked for any damages or discrepancies
- The buyer or third party, will have 20 minutes with the driver, in which to check all boxes and/or pallets to ensure they are complete, correct and in perfect condition. \*Please note this excludes parcel carrier service
- Any damages or discrepancies must be clearly signed for as such on the driver's delivery paperwork. Failure to do so will result in any claim being rejected
- Claims regarding goods that have been signed for as unchecked will be rejected
- Any damages and/or discrepancies must be reported within the terms of our after-sales policies. For further details on our policies please contact sales@tcgroupuk.com
- Any claims made outside of the above terms, will be handled at the after-sales department's discretion and may be rejected
- When reporting a fault, details of your original order, information on the packaging and the environment in which the product is used will be requested for any claims
- We reserve the right to supply replacement components and are under no obligation to replace complete products
- We reserve the right to request photographic evidence. It is the customer's responsibility to provide these upon request to assist in a claim
- We reserve the right to investigate any claim. We may require items to be returned to us, in order for us to carry out an inspection
- Faults reported without the necessary information for us to make a clear assessment, may be rejected
- Replacement parts and/or items will be despatched on a next day service where available. If the original order was delivered and installed, we can offer an installation for the replacement, this will be subject to delivery and installation lead times. We are not responsible for the fitting of replacement components not provided on a delivery and installation and will not accept any invoices from the buyer, relating to charges incurred through the fitting of components and/or building of replacements
- Full replacements must be requested through the after-sales department. Any replacement orders placed with the Sales Team may result in a claim being rejected
- If a fault is deemed to be customer abuse, not within manufacturing tolerances or caused by usage outside of warranty guidelines, any replacement components or product will be charged to the buyer without credit. If we have received goods for inspection and find no fault, the goods may be despatched back to the customer and the buyer will be charged for any collection and redelivery costs
- Any claims made outside of the above terms, will be handled at the after-sales department's discretion and may be rejected
- All returns must be pre-agreed with the after-sales department and a returns number obtained
- Items must be disassembled and securely boxed in the original packaging, including all internal protective packaging
- All boxes and pallets must have the collection note provided by after-sales firmly attached
- All boxes and pallets are kerbside only for collection
- Goods not securely boxed or palletised, may result in a failed collection and charges may apply
- Failed deliveries will be charged to the buyer. For confirmation of all charges please contact sales@tcgroupuk.com
- Any items that are simply no longer required by the buyer, can be returned to us as long as the goods comply with our returns policy. For confirmation of our policy and charges please contact sales@tcgroupuk.com. We reserve the right to reject returns which do not comply with our policy
- Any returns received outside of our policy may be charged back to the buyer or rejected and will be handled at the after-sales department's discretion



1300 Aztec West, Park Avenue,  
Aztec West, Bristol  
BS32 4RX, United Kingdom

T +44 (0) 1454 207360  
E [sales@tcgroupuk.com](mailto:sales@tcgroupuk.com)  
W [tcgroupuk.com](http://tcgroupuk.com)